



***Solutions For Your  
Racking System***



## *Closed Rack*

---

Perforated Door & Split Door	1
Perforated Door Split Door - Front & Rear	2
Perforated Door Front & Rear	3
Perforated Door & Perforated Back Door	4
Glass Door & Perforated Back Door	5
Colocation Server Rack	6
Rack With Biometric Security System	7
Intelligent Handle Rack	8

## *Rack With Cooling*

---

Standing Rack With Cooling	9
Smart Cabinet	10
Wallmount Rack With Cooling	11

## *Wallmount Rack*

---

Single Door	12
Double Door	13

## *Open Rack*

---

4 Post Open Rack	14
Open Entry Rack	15
Standard Open Rack	16

## *Outdoor Cabinet*

---

Outdoor Standing Cabinet (ODC)	17
Outdoor Standing Cabinet (ODC) With Cooling	18
Glass Door IP31   IP42   IP55	19
Outdoor Wall + Pole Mounted Rack	20
Outdoor Wall + Pole Mounted Rack With Cooling	21
Junction Box (JB)	22
Junction Box (JB) With Cooling	23

## *Customized Rack*

---

Telco & Battery Rack	24
Backup Tape Rack (LTO Rack)	25

## *Data Center Solutions*

---

Cold Aisle Containment System (CAC)	26
Hot Aisle Containment System (HAC)	27
Cages For Data Center	28

## *Accessories*

---

Accessories _____	29
-------------------	----

## *Closed Rack - Ago Series*

---

Glass Door & Perforated Back Door _____	31
Perforated Door Front & Rear _____	32
Perforated Door & Split Door _____	33
24 Inchi Perforated Door & Split Door _____	34

## *Wallmount Rack - Ago Series*

---

Single Door _____	35
Double Door _____	36
Outdoor Wall + Pole Mounted Rack _____	37

## Perforated Door and Split Door

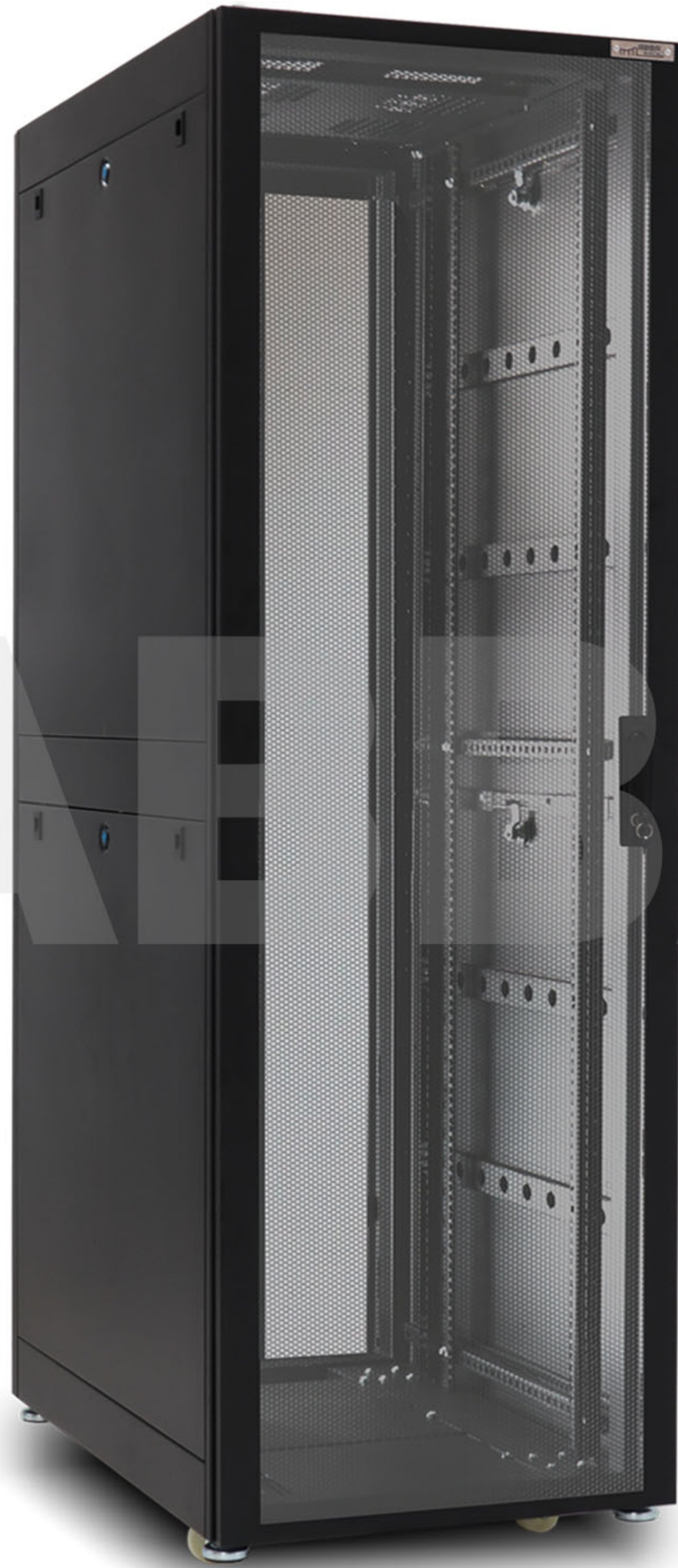

Maximum Static Load  
1500 kg



More Details :

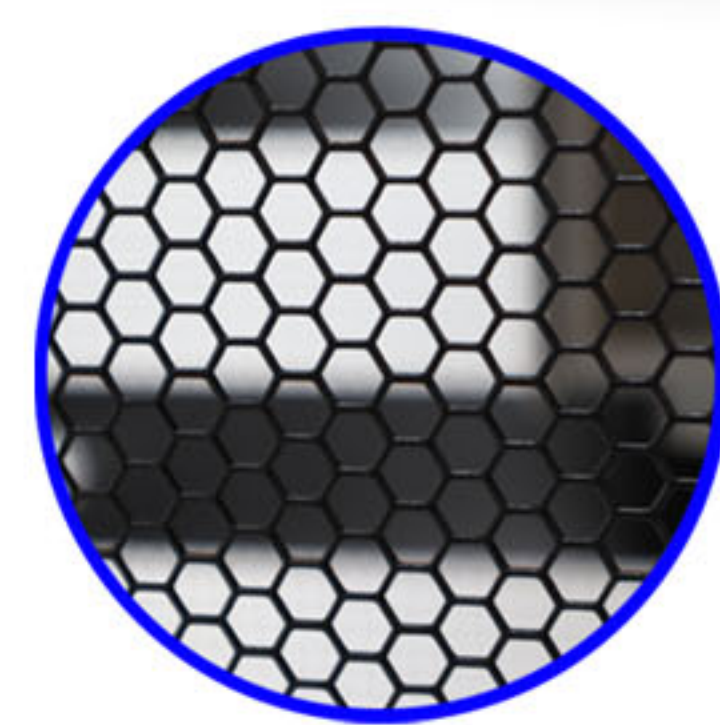

### Features :

1. 19" and 24" Closed rack type available.
2. Perforated front door & rear split door provide excellent ventilation and protection.
3. Hexagon perforation at front & rear door.
4. Numbered "U" positions.
5. Multifunctional roof design for cable entry, fan tray and aisle containment installations.
6. Top and bottom available with cable entry.
7. Easily Adjustable 19" mounting depth.
8. Dual section side panels with locking allows for easy removal / installation.
9. Easily adjustable levelling feet and casters.
10. Easy to assembled or disassembled.
11. Powder coating with chemical pre treatment, compact structure and high precision.
12. Various optional accessories.

### Specification 19" Perforated Door & Split Door

Part Number	Size	Width (mm)	Height (mm)	Depth (mm)
ABBA-NC20-10900-TG/TB	20U	600	1045	900
ABBA-NC20-11150-TG/TB	20U	600	1045	1150
ABBA-NC30-10900-TG/TB	30U	600	1490	900
ABBA-NC30-11150-TG/TB	30U	600	1490	1150
ABBA-NC42-10900-TG/TB	42U	600	2025	900
ABBA-NC42-11150-TG/TB	42U	600	2025	1150
ABBA-NC45-10900-TG/TB	45U	600	2160	900
ABBA-NC45-11150-TG/TB	45U	600	2160	1150

### Specification 24" Perforated Door & Split Door

Part Number	Size	Width (mm)	Height (mm)	Depth (mm)
ABBA-NC42-20900-TG/TB	42U	800	2025	900
ABBA-NC42-21150-TG/TB	42U	800	2025	1150
ABBA-NC45-20900-TG/TB	45U	800	2160	900
ABBA-NC45-21150-TG/TB	45U	800	2160	1150

## Perforated Split Door - Front & Rear



Maximum Static Load  
1500 kg



More Details :

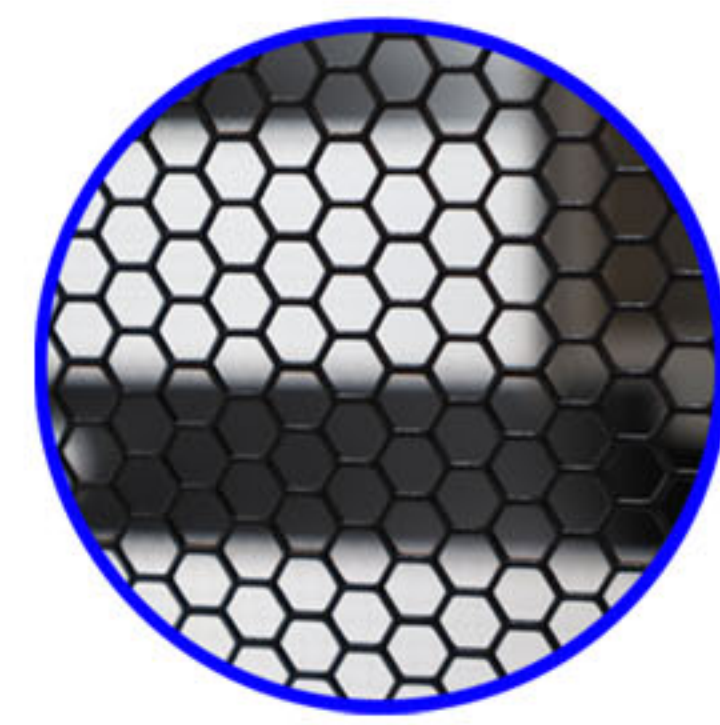

### Features :

1. 19" and 24" Closed rack type available.
2. Perforated front split door & rear split door provide excellent ventilation, protection and maximize room space.
3. Hexagon perforation at front & rear door.
4. Numbered "U" positions.
5. Multifunctional roof design for cable entry, fan tray and aisle containment installations.
6. Top and bottom available with cable entry.
7. Easily Adjustable 19" mounting depth.
8. Dual section side panels with locking allows for easy removal / installation.
9. Easily adjustable levelling feet and casters.
10. Easy to assembled or disassembled.
11. Powder coating with chemical pre treatment, compact structure and high precision.
12. Various optional accessories.

### Specification 19" Perforated Split Door Front & Rear

Part Number	Size	Width (mm)	Height (mm)	Depth (mm)
ABBA-NC20-10900-MG/MB	20U	600	1045	900
ABBA-NC20-11150-MG/MB	20U	600	1045	1150
ABBA-NC30-10900-MG/MB	30U	600	1490	900
ABBA-NC30-11150-MG/MB	30U	600	1490	1150
ABBA-NC42-10900-MG/MB	42U	600	2025	900
ABBA-NC42-11150-MG/MB	42U	600	2025	1150
ABBA-NC45-10900-MG/MB	45U	600	2160	900
ABBA-NC45-11150-MG/MB	45U	600	2160	1150

### Specification 24" Perforated Split Door Front & Rear

Part Number	Size	Width (mm)	Height (mm)	Depth (mm)
ABBA-NC42-20900-MG/MB	42U	800	2025	900
ABBA-NC42-21150-MG/MB	42U	800	2025	1150
ABBA-NC45-20900-MG/MB	45U	800	2160	900
ABBA-NC45-21150-MG/MB	45U	800	2160	1150

## Perforated Door Front & Rear

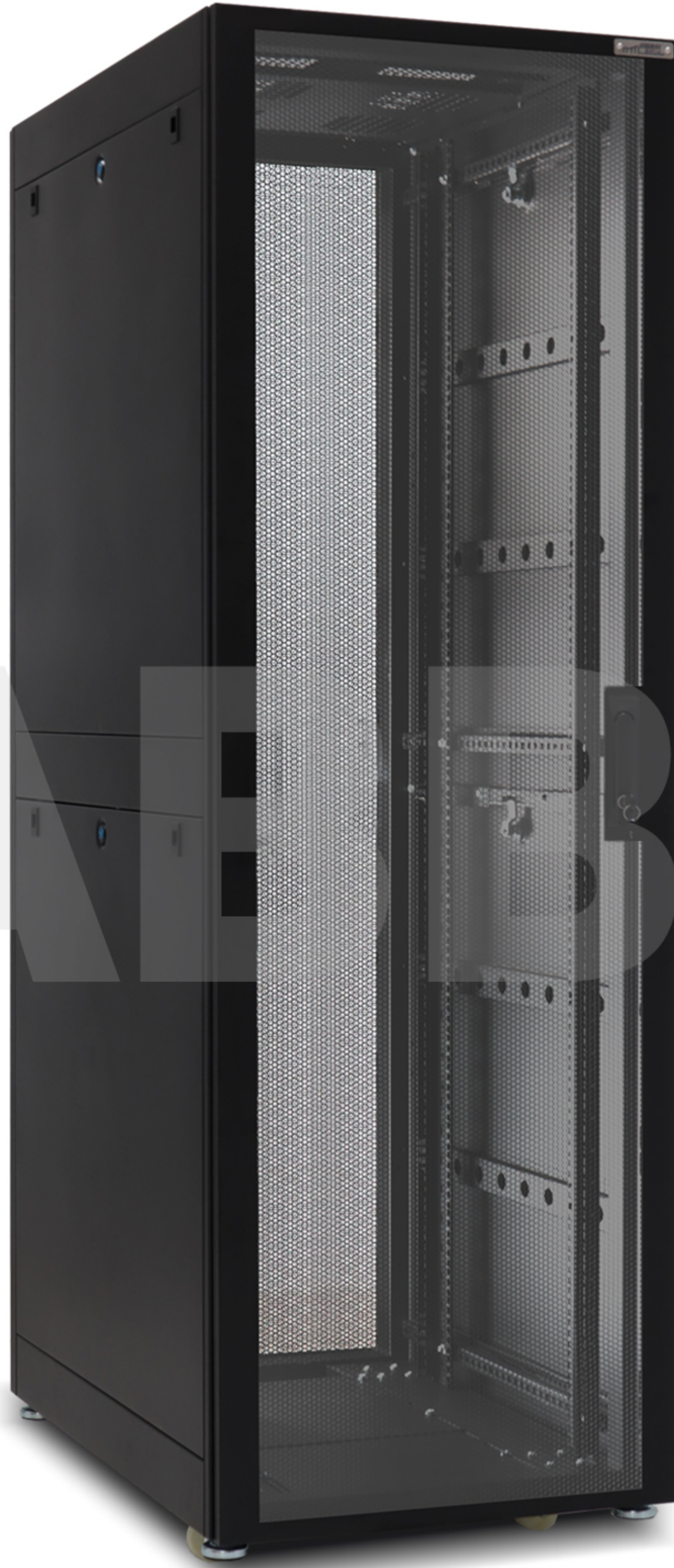

Maximum Static Load  
1500 kg



More Details :

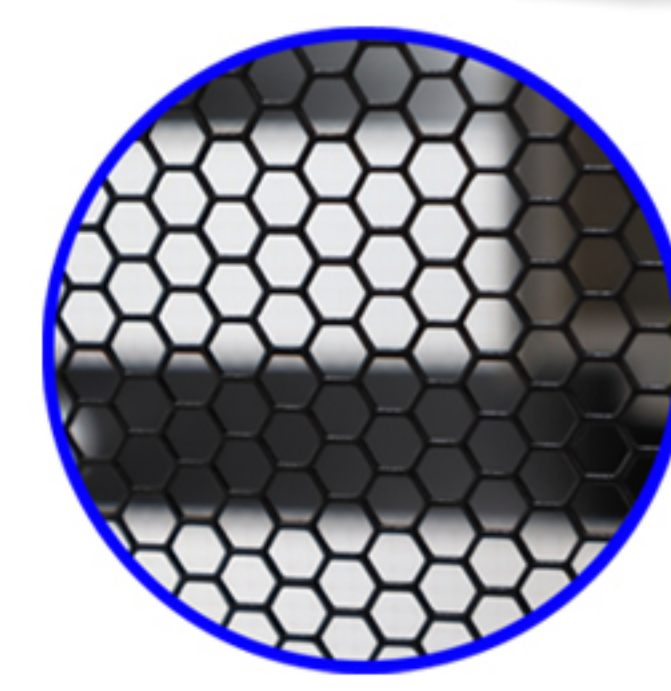

### Features :

1. 19" and 24" Closed rack type available.
2. Perforated door front & rear provide excellent ventilation and protection.
3. Hexagon perforation at front door and square perforation at back door.
4. Numbered "U" positions.
5. Multifunctional roof design for cable entry, fan tray and aisle containment installations.
6. Top and bottom available with cable entry.
7. Easily Adjustable 19" mounting depth.
8. Dual section side panels with locking allows for easy removal / installation.
9. Easily adjustable levelling feet and casters.
10. Easy to assembled or disassembled.
11. Powder coating with chemical pre treatment, compact structure and high precision.
12. Various optional accessories.

### Spesification 19" Perforated Door Front & Rear

Part Number	Size	Width (mm)	Height (mm)	Depth (mm)
ABBA-NC20-10900-PPG/PPB	20U	600	1045	900
ABBA-NC20-11150-PPG/PPB	20U	600	1045	1150
ABBA-NC30-10900-PPG/PPB	30U	600	1490	900
ABBA-NC30-11150-PPG/PPB	30U	600	1490	1150
ABBA-NC42-10900-PPG/PPB	42U	600	2025	900
ABBA-NC42-11150-PPG/PPB	42U	600	2025	1150
ABBA-NC42-11200-PPG/PPB	42U	600	2025	1200
ABBA-NC45-10900-PPG/PPB	45U	600	2160	900
ABBA-NC45-11150-PPG/PPB	45U	600	2160	1150
ABBA-NC45-11200-PPG/PPB	45U	600	2160	1200

### Spesification 24" Perforated Door Front & Rear

Part Number	Size	Width (mm)	Height (mm)	Depth (mm)
ABBA-NC42-20900-PPG/PPB	42U	800	2025	900
ABBA-NC42-21150-PPG/PPB	42U	800	2025	1150
ABBA-NC45-20900-PPG/PPB	45U	800	2160	900
ABBA-NC45-21150-PPG/PPB	45U	800	2160	1150

## Perforated Door & Perforated Back Door

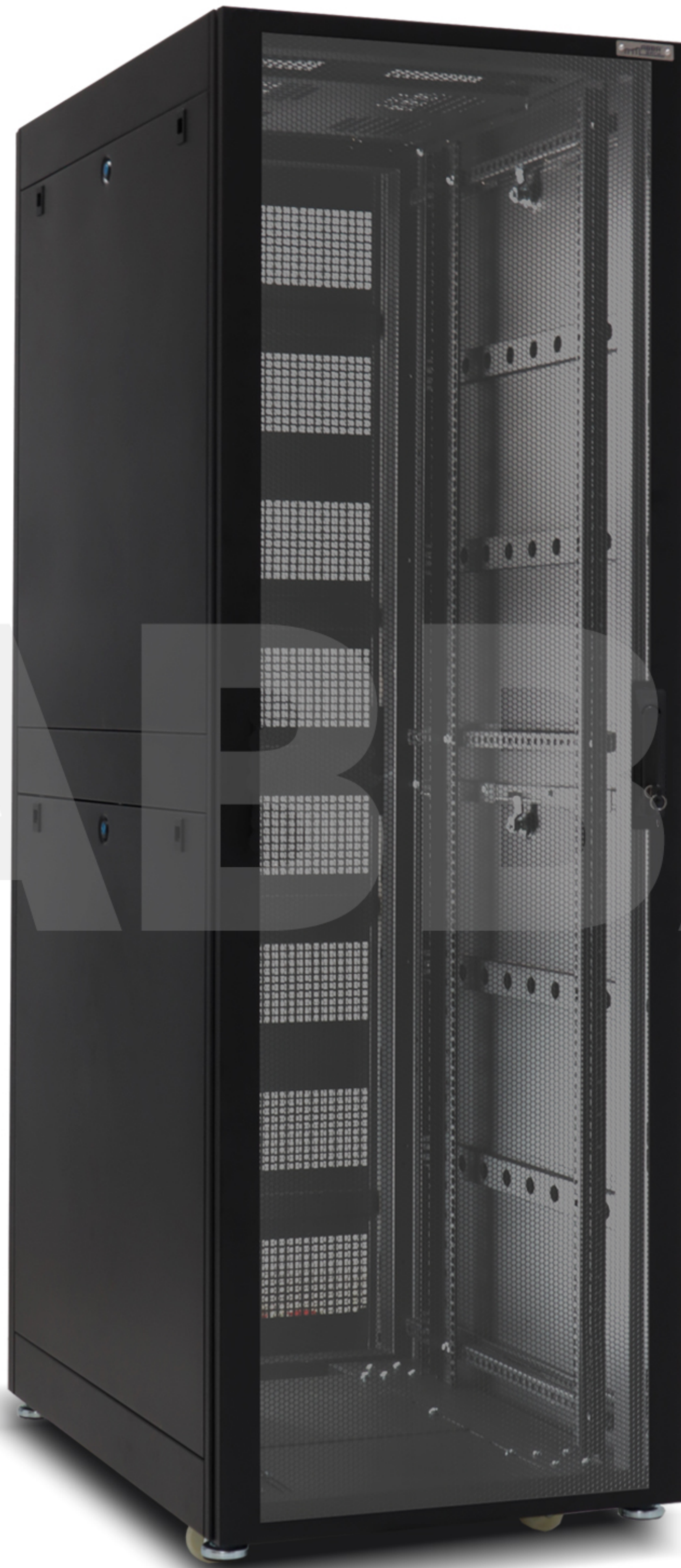

Maximum Static Load  
1500 kg

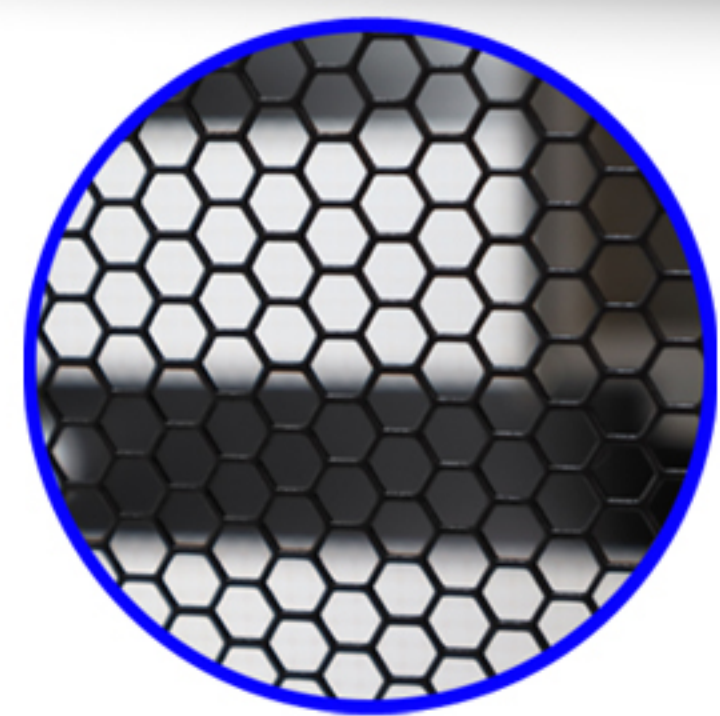

### Features :

1. 19" and 24" Closed rack type available.
2. Perforated front door & Perforated back door provide excellent ventilation and protection.
3. Hexagon perforation at front door and square perforation at back door.
4. Numbered "U" positions.
5. Multifunctional roof design for cable entry, fan tray and aisle containment installations.
6. Top and bottom available with cable entry.
7. Easily Adjustable 19" mounting depth.
8. Dual section side panels with locking allows for easy removal / installation.
9. Easily adjustable levelling feet and casters.
10. Easy to assembled or disassembled.
11. Powder coating with chemical pre treatment, compact structure and high precision.
12. Various optional accessories.

### Specification 19" Perforated Door & Perforated Back Door

Part Number	Size	Width (mm)	Height (mm)	Depth (mm)
ABBA-NC20-10900-PG/PB	20U	600	1045	900
ABBA-NC20-11150-PG/PB	20U	600	1045	1150
ABBA-NC30-10900-PG/PB	30U	600	1490	900
ABBA-NC30-11150-PG/PB	30U	600	1490	1150
ABBA-NC42-10900-PG/PB	42U	600	2025	900
ABBA-NC42-11150-PG/PB	42U	600	2025	1150
ABBA-NC45-10900-PG/PB	45U	600	2160	900
ABBA-NC45-11150-PG/PB	45U	600	2160	1150

### Specification 24" Perforated Door & Perforated Back Door

Part Number	Size	Width (mm)	Height (mm)	Depth (mm)
ABBA-NC42-20900-PG/PB	42U	800	2025	900
ABBA-NC42-21150-PG/PB	42U	800	2025	1150
ABBA-NC45-20900-PG/PB	45U	800	2160	900
ABBA-NC45-21150-PG/PB	45U	800	2160	1150

## Glass Door & Perforated Back Door



More Details :



Maximum Static Load  
1500 kg

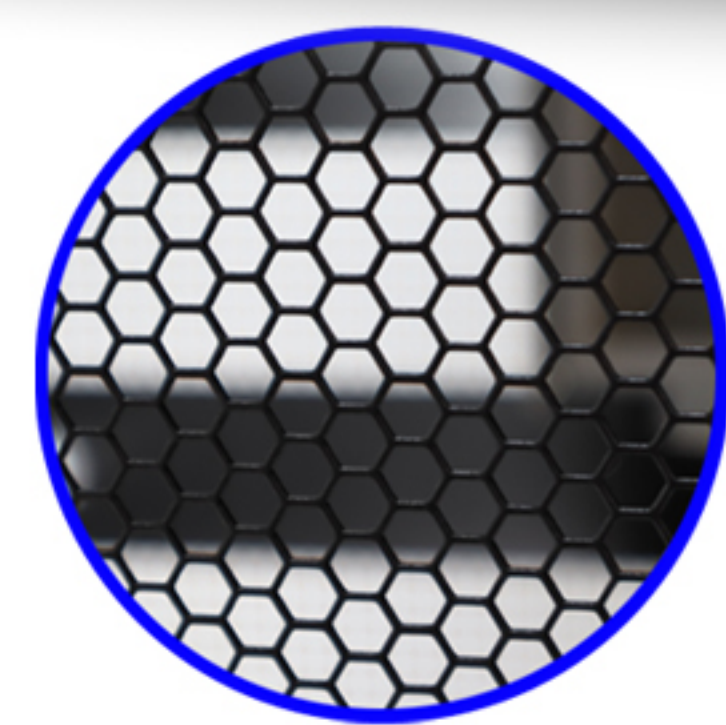

### Features :

1. 19" and 24" Closed rack type available.
2. Transparent Glass front door & Perforated back door provide protection & cabinet inside view.
3. Square perforation at front door and back door.
4. Numbered "U" positions.
5. Multifunctional roof design for cable entry, fan tray and aisle containment installations.
6. Top and bottom available with cable entry.
7. Easily Adjustable 19" mounting depth.
8. Dual section side panels with locking allows for easy removal / installation.
9. Easily adjustable levelling feet and casters.
10. Easy to assembled or disassembled.
11. Powder coating with chemical pre treatment, compact structure and high precision.
12. Various optional accessories.

### Specification 19" Glass Door & Perforated Back Door

Part Number	Size	Width (mm)	Height (mm)	Depth (mm)
ABBA-NC20-10900-GG/GB	20U	600	1045	900
ABBA-NC20-11150-GG/GB	20U	600	1045	1150
ABBA-NC30-10900-GG/GB	30U	600	1490	900
ABBA-NC30-11150-GG/GB	30U	600	1490	1150
ABBA-NC42-10900-GG/GB	42U	600	2025	900
ABBA-NC42-11150-GG/GB	42U	600	2025	1150
ABBA-NC45-10900-GG/GB	45U	600	2160	900
ABBA-NC45-11150-GG/GB	45U	600	2160	1150

### Specification 24" Glass Door & Perforated Back Door

Part Number	Size	Width (mm)	Height (mm)	Depth (mm)
ABBA-NC42-20900-GG/GB	42U	800	2025	900
ABBA-NC42-21150-GG/GB	42U	800	2025	1150
ABBA-NC45-20900-GG/GB	45U	800	2160	900
ABBA-NC45-21150-GG/GB	45U	800	2160	1150

## Data Center Solutions



More Details :

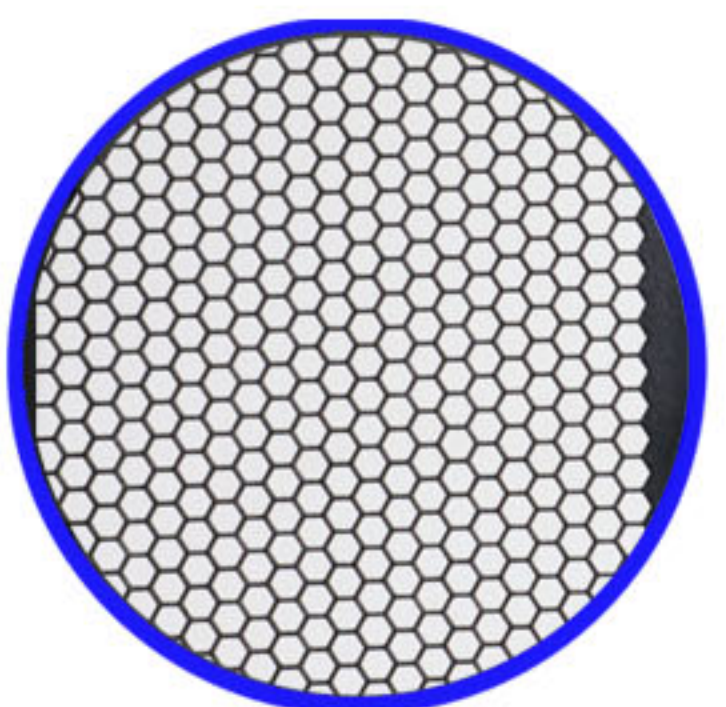

### Features :

1. Available with 2, 3, 4, 5 up to 9 compartment
2. Secure and isolated cable channel each individual compartment
3. Unique key for each compartment
4. 19" & 24" type available
5. Adjustable 19" mounting depth
6. Fully assembled and ready to use
7. Top & bottom with cable entry
8. Tenant cannot remove compartment divider
9. Perforated door provide maximum air flow
10. Clearly rack unit "U" marking
11. Available sizes : 42U and 45U
12. Available customized on requirements

### Specification 19" Colocation Server Rack

Part Number	Compartment	Size	Width (mm)	Height (mm)	Depth (mm)
ABBA-C42-10900CR2C-G/B	2 Section 20U	42U   19"	600	2075	900
ABBA-C42-11150CR2C-G/B	2 Section 20U	42U   19"	600	2075	1150
ABBA-C42-10900CR4C-G/B	4 Section 10U	42U   19"	600	2075	900
ABBA-C45-11150CR3C-G/B	3 Section 14U	45U   19"	600	2210	1150

### Specification 24" Colocation Server Rack

Part Number	Compartment	Size	Width (mm)	Height (mm)	Depth (mm)
ABBA-C42-20900CR2C-G/B	2 Section 20U	42U   24"	800	2075	900
ABBA-C42-21150CR2C-G/B	2 Section 20U	42U   24"	800	2075	1150
ABBA-C42-20900CR4C-G/B	4 Section 10U	42U   24"	800	2075	900
ABBA-C45-21150CR3C-G/B	3 Section 14U	45U   24"	800	2210	1150



Server Rack



Colocation Rack



Maximum Static Load  
1500 kg

**Colour**



**Biometric Server Rack Features:**

1. 19" Closed rack with Biometric Access Control Standalone
2. 3 in 1 access the door Fingerprint/RFID card/PIN
3. Fingerprint capacity: 500, Card capacity: 500, PIN capacity: 500
4. Smart Narrow Frame design LED status indicators
5. Easy operation and management
6. Magnetic locking system
7. Mechanical key support
8. Upgrade available to the networked access function

**Biometric Colocation Rack Features:**

1. 19" Colocation Rack with Biometric Access Control Standalone
2. 3 in 1 access the door Fingerprint/RFID card/PIN
3. Fingerprint capacity: 500, Card capacity: 500, PIN capacity: 500
4. Smart Narrow Frame design LED status indicators
5. Easy operation and management
6. Magnetic locking system
7. Mechanical key support
8. Upgrade available to the networked access function

**Specification Biometric Server Rack & Colocation Rack**

Part Number	Size	Width (mm)	Height (mm)	Depth (mm)	Type
ABBA-NC42-11150-SBR-G/B	42U	600	2025	1150	Server Rack
ABBA-C42-11150-CR2C-SBR-G/B	42U	600	2025	1150	Colocation Rack

- 8\* - Networked Access Controller Function
- TCP/IP communication
- Free Access Control Management Software
- Access Privilege Management
- Real time monitoring
- Door access record



More Details :

## Intelligent Handle Rack



### Colour

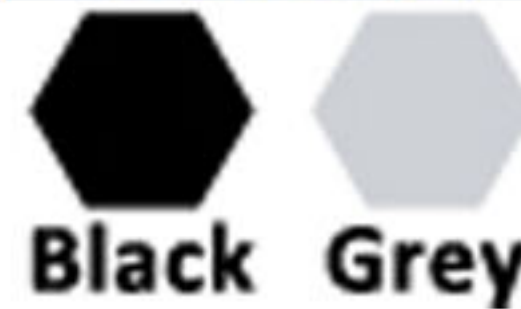

Black Grey



Maximum Static Load  
1500 kg



LED Light Bar



More Details :



### Features :

1. ABBA RACK with secured door lock access control
2. Proximity or MiFARE smartcard Optional
3. Include LED light bar with IR sensor On/Off with magnetic base for easy installation
4. Handle LED for lock status indication
5. 19" and 24" Closed rack type available.
6. Perforated front door & rear split door provide excellent ventilation and protection.
7. Hexagon perforation at front & rear door.
8. Numbered "U" positions.
9. Multifunctional roof design for cable entry, fan tray and aisle containment installations.

10. Top and bottom available with cable entry.
11. Easily Adjustable 19" mounting depth.
12. Dual section side panels with locking allows for easy removal / installation.
13. Easily adjustable levelling feet and casters.
14. Easy to assembled or disassembled.
15. Powder coating with chemical pre treatment, compact structure and high precision.
16. Various optional accessories.

### Specification Intelligent Handle Rack

Part Number	Size	Width (mm)	Height (mm)	Depth (mm)
ABBA-NC42-11150-PG/PB-IHLB	42U	600	2025	1150
ABBA-NC45-11150-PG/PB-IHLB	45U	600	2160	1150

## SC1 Series

## Standing Rack With Cooling ( Indoor )

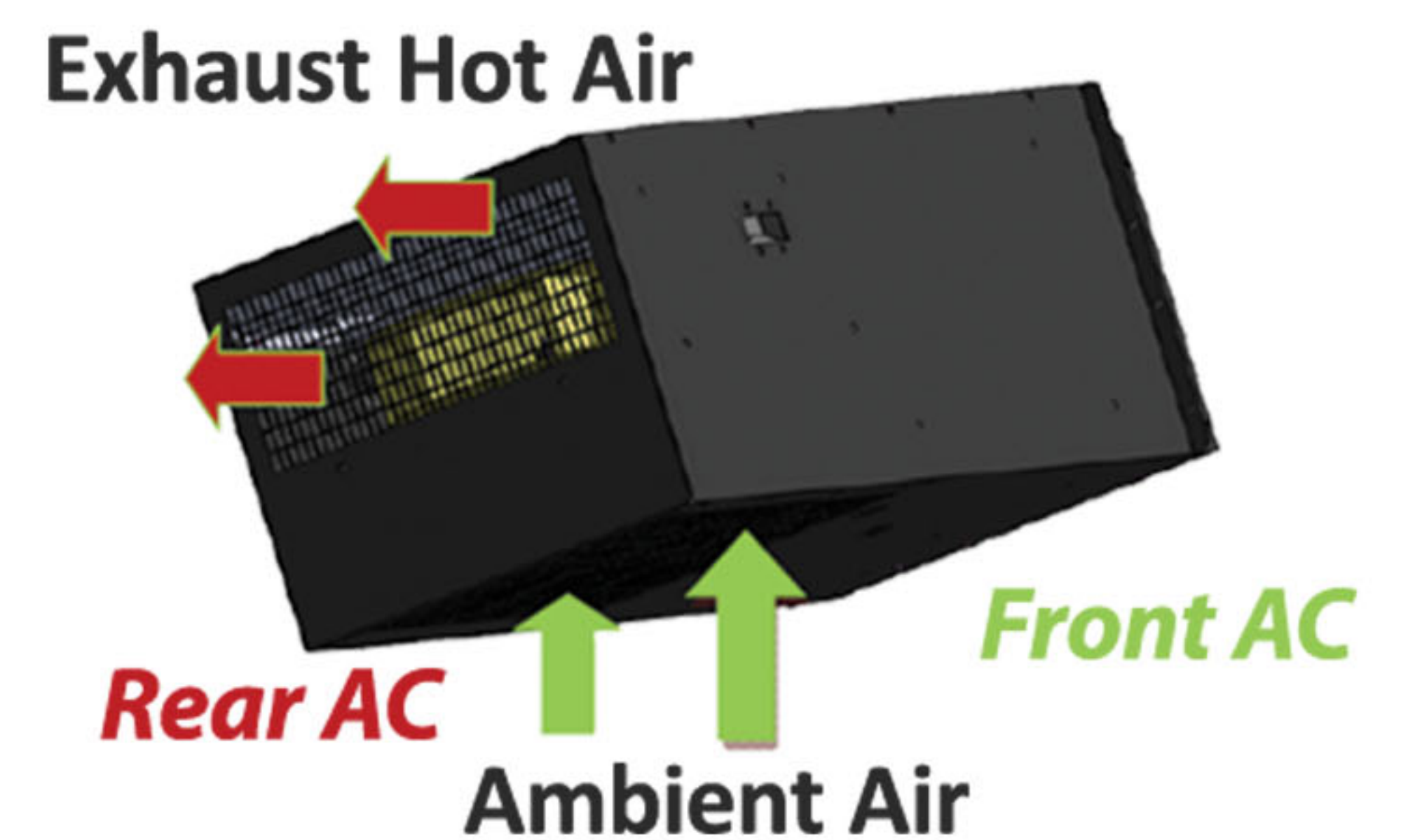
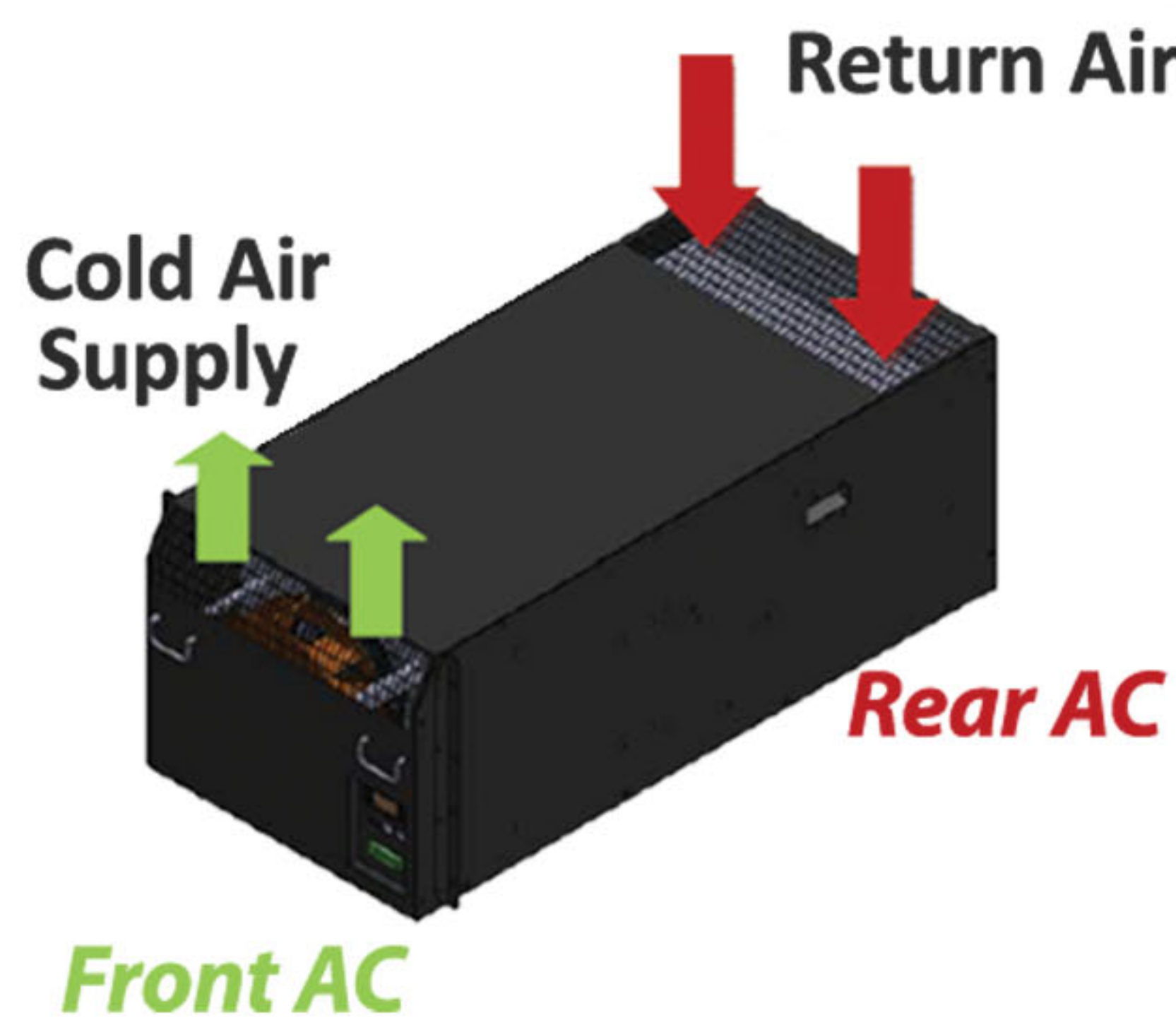

### Features:

1. 19 inch server rack with cooling is ideal for self containment for security purposes.
2. Rack with cooling saves energy and reduces your operating costs.
3. Saves valuable floor space in your IT environment.
4. Keeping your rack equipment cool and in reliable.
5. Designed for easy and convenient operation.
6. Air conditioner rackmounted, all in one unit.
7. Cooling capacity 3.5kW.
8. Isolates cold and hot area to optimize cooling system efficiency.
9. Available rackmount space 32U & 35U.

### Specification Air Conditioned Server Rack

Part Number	Size	Width (mm)	Height (mm)	Depth (mm)
ABBA-C42-11100-SC1-B	42U	600	2002	1100
ABBA-C42-21100-SC1-G	42U	800	2002	1100
ABBA-C45-11100-SC1-B	45U	600	2140	1100
ABBA-C45-21100-SC1-G	45U	800	2140	1100

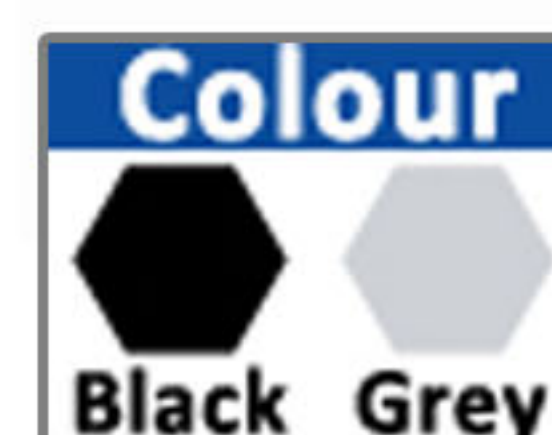

More Details :

## SC2 Series

Rack + Cooling + EMS LCD Display  
+ Biometric Access Door



10" LCD display for Environmental Monitoring System



3 in 1 Biometric Access System



Fingerprint



RFID Card



PIN/Password



Network Access Control



Mechanical Key

Air Conditioner

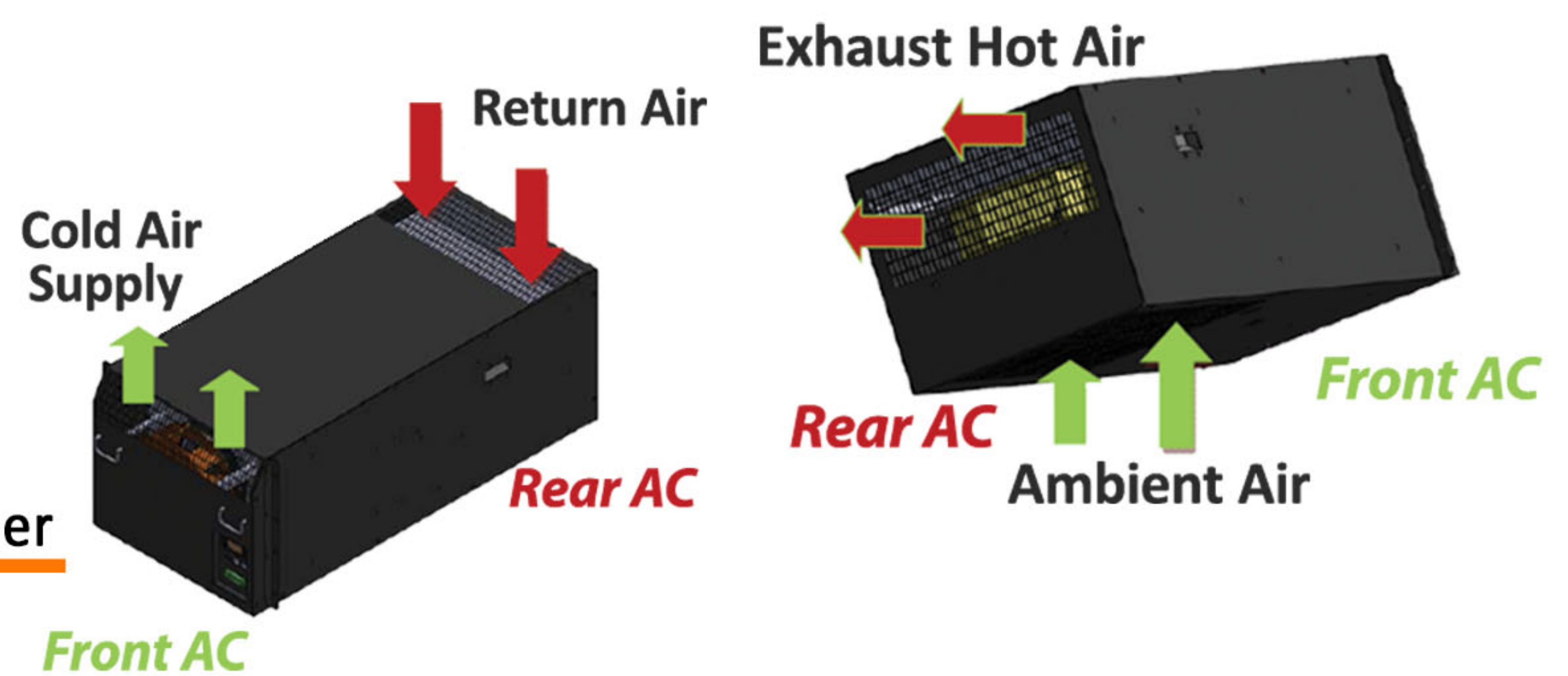

### Features:

1. Available in 19"/24", 42U/45U with depth 1100mm  
*Part Number 19" 42U = ABBA-C42-11110-SC2-G/B*  
*Part Number 24" 42U = ABBA-C42-21110-SC2-G/B*
2. Available space for IT Device 32U/35U
3. 3 in 1 Biometric Access Door System
4. Networked Access Controller
5. 3 ways to open the door via Fingerprint/Card/PIN
6. TCP/IP communications
7. Free Access Control Management Software
8. Access Privilege Management
9. Real time monitoring
10. Door access record
11. Air Conditioner, Rackmounted all in one cooling
12. Cooling Capacity 3.5kW
13. 10" LCD display for Environmental Monitoring System with LAN port connection, Door mounted
14. Sensor : Temperature & humidity, Smoke detector, non locating water sensor, Door switch
15. Vertical PDU 12 outlet Schuko 32A with Ampere & Volt Meter Display, input plug EN60309
16. 50 Pcs Cage Nut & M6 Screw
17. 4 Unit Adjustable Feet
18. 27 Pcs Toolless Blank Panel, 1U
19. 1 Set Castor (set of 4 Pcs )

### Optional :

- 6 kVA online UPS + Battery Pack
- Intelligent PDU



More Details :

## Wallmount Rack with Cooling (Indoor)



### Features :

1. 19" wallmount rack built in with the cooling for self containment for security purposes.
2. Saves energy and reduces your operating costs.
3. Saves valuable floor space in your IT environment.
4. Keeping your rack equipment cool and in reliable.
5. Designed for easy and convenient operation.
6. Air conditioner doormounted, all in one unit.
7. Cooling capacity 300W.
8. Optimize cooling system efficiency.
9. Available on standard 10U, 12U and 15U or customized.

Specification Wallmount Rack With Cooling				
Part Number	Size	Width (mm)	Height (mm)	Depth (mm)
ABBA-W10-500-AC-SG/SB	10U	550	527	500
ABBA-W12-500-AC-SG/SB	12U	550	625	500
ABBA-W15-500-AC-SG/SB	15U	550	765	500



More Details :

## Single Door



Single Door  
Removable Side Panel\*



Single Door - Standard



More Details :



### Features :

1. 19" Standard installation
2. Single section welded frame structure
3. Powder coating with chemical pre treatment
4. Cable entry at the top and bottom panel
5. Lockable door
6. Ventilated at the door, top, bottom & side panel
7. Adjustable mounting depth
8. Available in 2 types front door : Acrylic & Perforated door
9. \*Removable Side Panel for ease access and maintenance
10. \*Easy operation and maintaining at the back

Wallmount Rack Single Door - Removable Side Panel

Part Number	Size	Width (mm)	Height (mm)	Depth (mm)
ABBA-W02-500-SG/SB	2U	550	171	500
ABBA-W04-500-SG/SB	4U	550	260	500
ABBA-W06-500-SG/SB	6U	550	349	500
ABBA-W08-500-SG/SB	8U	550	438	500
ABBA-W10-500-SG/SB	10U	550	527	500

Wallmount Rack Single Door - Standard

Part Number	Size	Width (mm)	Height (mm)	Depth (mm)
ABBA-W08-450-SG/SB	8U	550	438	450
ABBA-W12-450-SG/SB	12U	550	616	450
ABBA-W15-450-SG/SB	15U	550	750	450

## Double Door



### Features :

1. 19" Standard installation
2. Double section welded frame structure
3. Powder coating with chemical pre treatment
4. Cable entry at the top and bottom panel
5. Lockable door
6. Ventilated at the door, top, bottom & side panel
7. Adjustable mounting depth
8. Available in 2 types front door : Acrylic & Perforated door
9. Easy operation and maintaining at the back
10. Turning angle of rear door is above 180 degrees

Wallmount Rack Double Door - Standard				
Part Number	Size	Width (mm)	Height (mm)	Depth (mm)
ABBA-W08-490-DG/DB	8U	600	438	490
ABBA-W08-600-DG/DB	8U	600	438	600
ABBA-W12-490-DG/DB	12U	600	616	490
ABBA-W12-600-DG/DB	12U	600	616	600
ABBA-W15-490-DG/DB	15U	600	750	490
ABBA-W15-600-DG/DB	15U	600	750	600
ABBA-W15-750-DG/DB	15U	600	750	750



More Details :

## 4 Post Open Rack

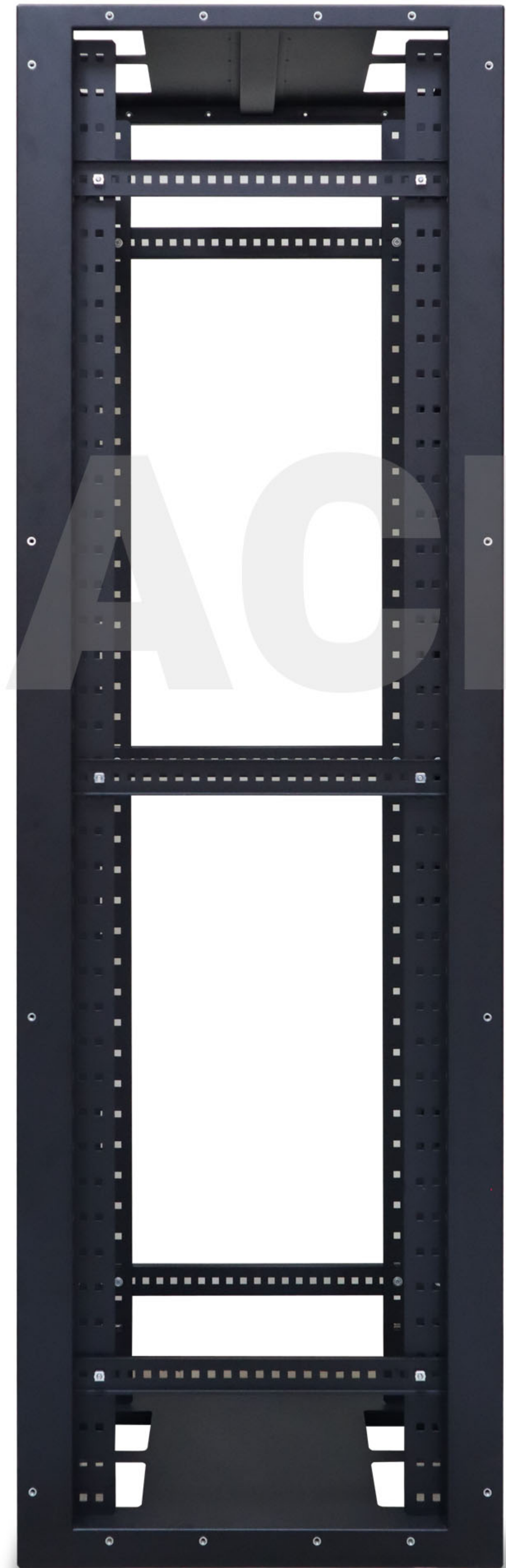

19" Open Rack 4 Post are a low cost option for rack your servers and network equipments.

It is an ideal for rack mount servers, KVM switch, networking and rackmount equipment where security at the rack level is not required.

A cost-effective solution, the rack is constructed of high quality materials.

Available on standard :

Size : 42U and 45U

Width : 600mm

Depth : 600mm and 900mm

Specification 4 Post Open Rack				
Part Number	Size	Width (mm)	Height (mm)	Depth (mm)
ABBA-O4P-42-600-G/B	42U	600	2000	600
ABBA-O4P-45-600-G/B	45U	600	2140	600
ABBA-O4P-42-900-G/B	42U	600	2000	900
ABBA-O4P-45-900-G/B	45U	600	2140	900

*\*Available customized on requirements*



More Details :

## Open Entry Rack

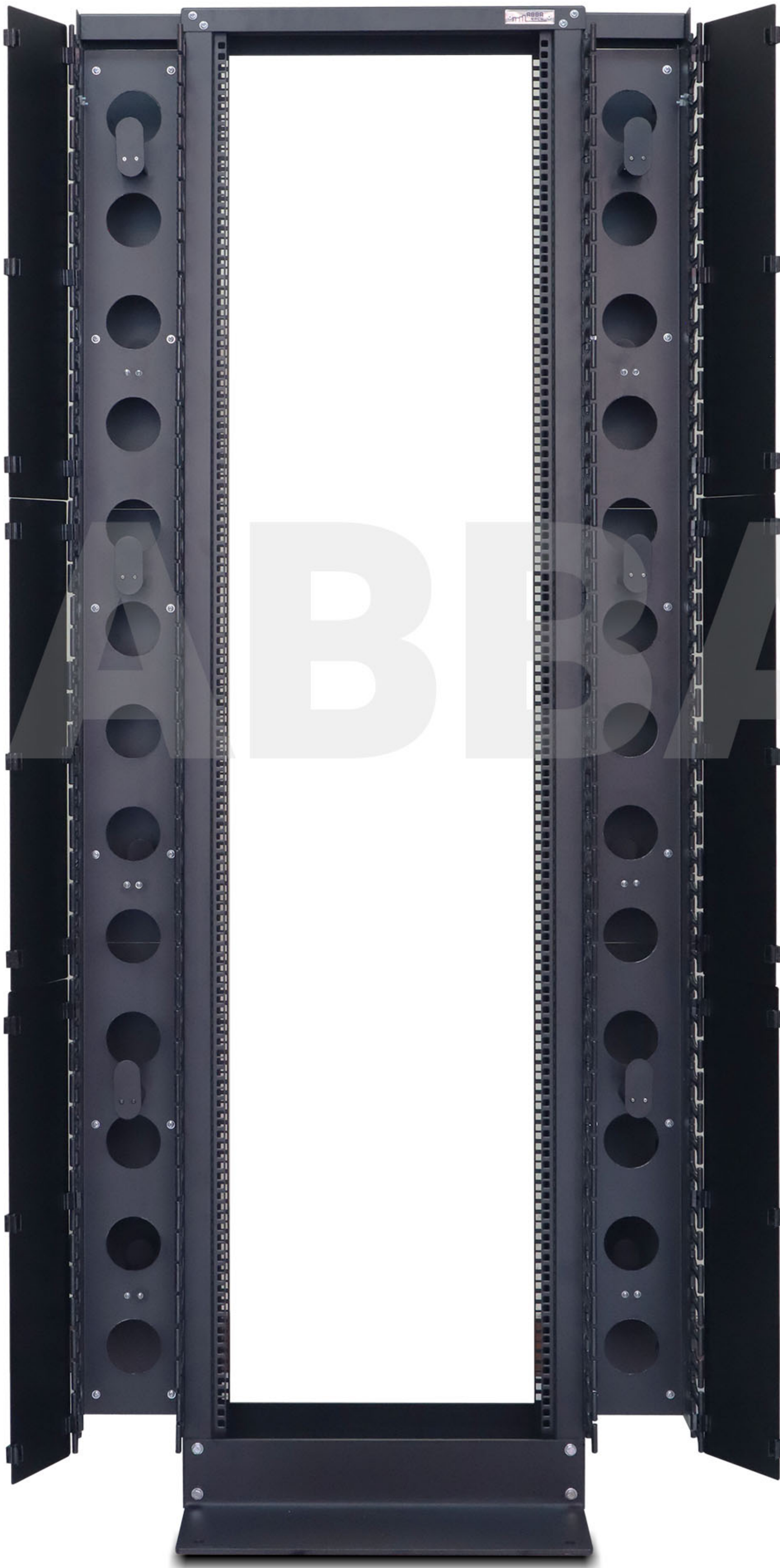

More Details :

### Features :

1. 19" standard installation
2. Available on standard : 42U and 45U
3. Open rack designed to be bolted to the floor
4. Vertical cable duct in front and rear side for cover the space to protect and manage cables (D.145 x W.150mm)
5. Cable spool inside the cable duct
6. Powder coating with chemical pre treatment, compact structure and high precision
7. It is an ideal for meet me room and simple solution for housing IT equipment that don't require a lockable rack solution
8. Easy access & installation for cables, cross patching and IT equipment
9. Maximizing useable space and minimize footprint
10. Various optional accessories according to requirements
11. Available customized on requirements



### Specification Open Entry Rack

Part Number	Size	Width (mm)	Height (mm)	Base (mm)
ABBA-O42-B-CD	42U	875	2020	580
ABBA-O45-B-CD	45U	875	2150	580
ABBA-O42-G-CD	42U	875	2020	580
ABBA-O42-G-CD	45U	875	2150	580



## Standard Open Rack

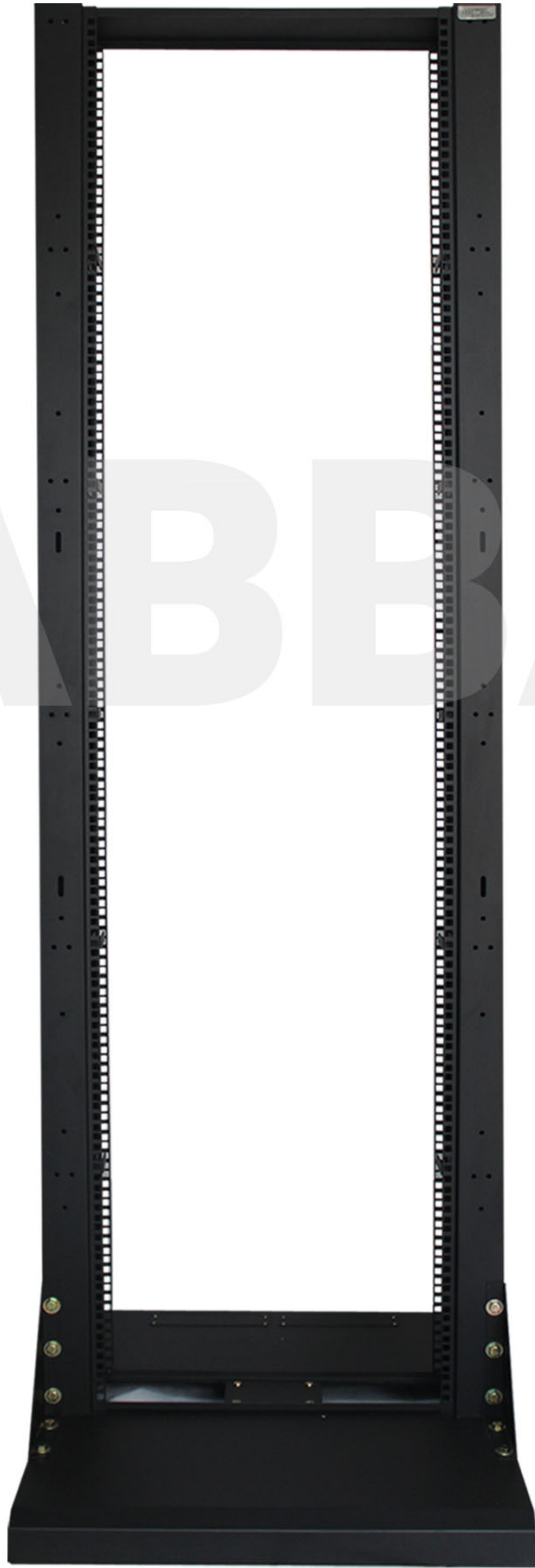

More Details :



### Features :

1. 19" standard installation
2. Available on standard : 25U, 30U, 42U and 45U
3. Powder coating with chemical pre treatment, compact structure and high precision
4. It is cost effective and simple solution that don't require a lockable rack solution
5. Easy access & installation for cables, cross patching and IT equipment
6. Maximizing useable space and minimize footprint
7. Available optional with castor and levelling feet
8. Various optional accessories according to requirements
9. Available customized on requirements



### Specification Standard Open Rack

Part Number	Size	Width (mm)	Height (mm)	Base (mm)
ABBA-O25-G/B	25U	615	1210	800
ABBA-O30-G/B	30U	615	1430	800
ABBA-O42-G/B	42U	615	1960	800
ABBA-O45-G/B	45U	615	2100	800



## Outdoor Standing Cabinet (ODC)

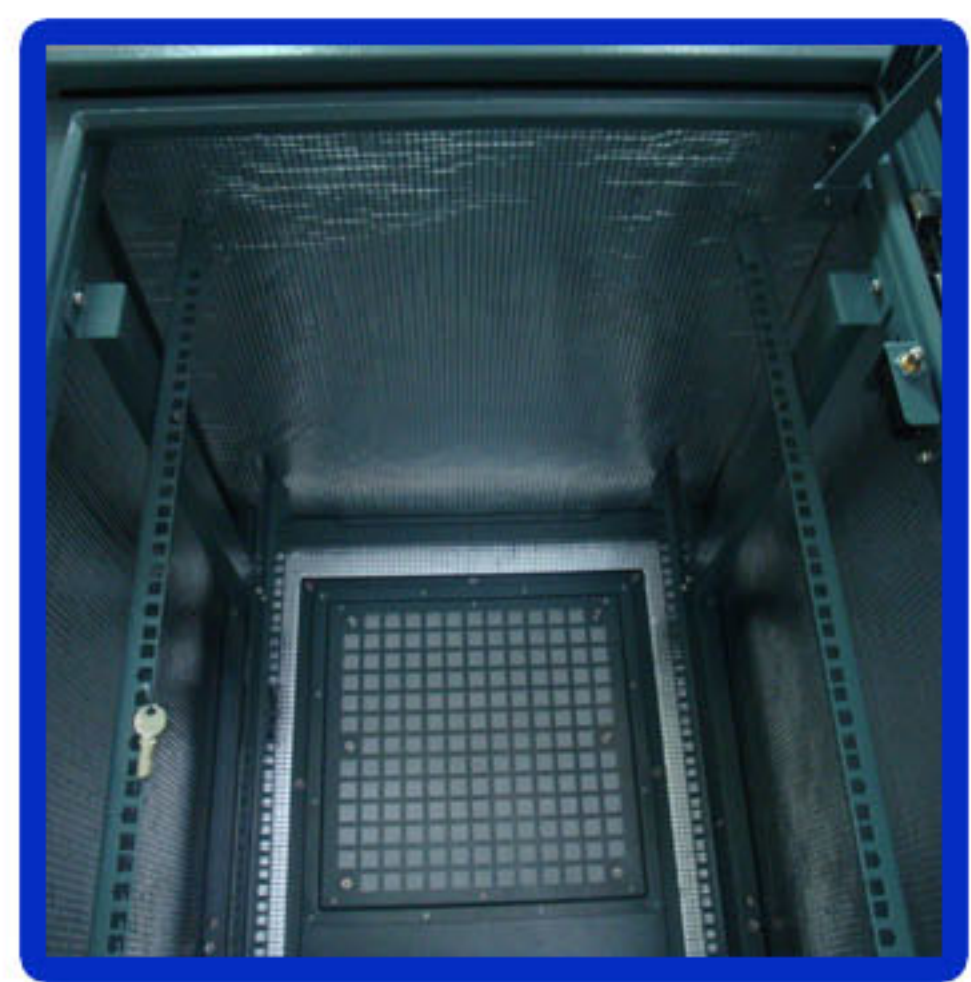

Door Switch + PE Foam



Laptop & Paper Patch



Handle Cover



Door Gasket & Lock  
Door Stopper



Exhaust Fans



Ventilation Cover

### Features:

1. 19" Outdoor standing cabinet type
2. Outdoor cabinet category IP55, IP56, IP65, etc
3. High quality powder coated, construction and design
4. Fixed mounting rails for support of patch panels, termination blocks and other equipments
5. Material options : SPCC Steel, Aluminium and Stainless Steel
6. Various optional accessories according to requirements (cable management, pdu, fans, utp panel, fo panel, etc)
7. Available customized on requirements

### Specification Outdoor Cabinet - Closed Rack

Part Number	Size	Width (mm)	Height (mm)	Depth (mm)
ABBA-C20U9060-IP55-RAL7035	20U	600	1150	900
ABBA-C30U9060-IP55-RAL7035	30U	600	1600	900
ABBA-C42U9060-IP55-RAL7035	42U	600	2150	900
ABBA-C20U9060-IP65-RAL7035	20U	600	1150	900
ABBA-C30U9060-IP65-RAL7035	30U	600	1600	900
ABBA-C42U9060-IP65-RAL7035	42U	600	2150	900



More Details :

## Outdoor Standing Cabinet with Cooling



More Details :



### Features:

1. 19 inch server rack with cooling is ideal for self containment for security purposes
2. Outdoor cabinet category IP55, IP56, IP65, etc
3. Air conditioner door mounted, all in one unit.
4. Cooling capacity : 800w, 1000w
5. High quality powder coated, construction and design
6. Material options : SPCC Steel, Aluminium and Stainless Steel
7. Color : RAL7035
8. Fixed mounting rails for support of patch panels, termination blocks and other equipments
9. Various optional accessories according to requirements (cable management, pdu, fans, utp panel, fo panel, etc)
10. Available customized on requirements

### Specification Outdoor Standing Cabinet with Cooling

Part Number	Size	Width (mm)	Height (mm)	Depth (mm)
ABBA-C20U9060-AC-IP65-RAL7035	20U	600	1150	900
ABBA-C30U9060-AC-IP65-RAL7035	30U	600	1600	900
ABBA-C42U9060-AC-IP65-RAL7035	42U	600	2150	900



### CABINET SPECIFICATIONS :

- Material : SPCC Mild Steel
- Color : RAL7035
- Base Plinth : 100mm
- Single Leave Glass Front Door
- Single Leave Back Metal Door
- Removable aluminum Bottom gland plate, THK. 5 mm
- 2 Set 19" Mounting Angle
- Handle with 4 Point Lock
- Lock Insert
- Document Holder (rear)
- Door switch (front & rear) and lamp (rear)
- 1 Unit ClimaSys forced vent. IP54, 300m<sup>3</sup>/h, 230V, with outlet grille and filter G2 (Exhaust Fan)
- 1 Unit outlet grille plast cut out 223x223mm ext dim 268x248mm, IP54 and filter G2
- 1 Unit PDU 8 Outlet Schuko, 16A Surge Protection With Switch On/Off
- 20 Pcs Cage nut and Bolt M6 Stainless Steel
- 2 Unit Grounding bar, cutting plated 10 holes suitable for 25 sqmm (W.25mm x L.265mm x T.3mm)
- 4 Unit Eye bolt Stainless Steel
- 2 Unit Door Stopper
- Bolt, nut, washer, screw Stainless Steel (rack fastener)
- Swing handle with flat rod control for rod with dual catch
- Include IP Rate Self Certificate



More Details :

## Outdoor Wall + Pole Mounted Rack



More Details :

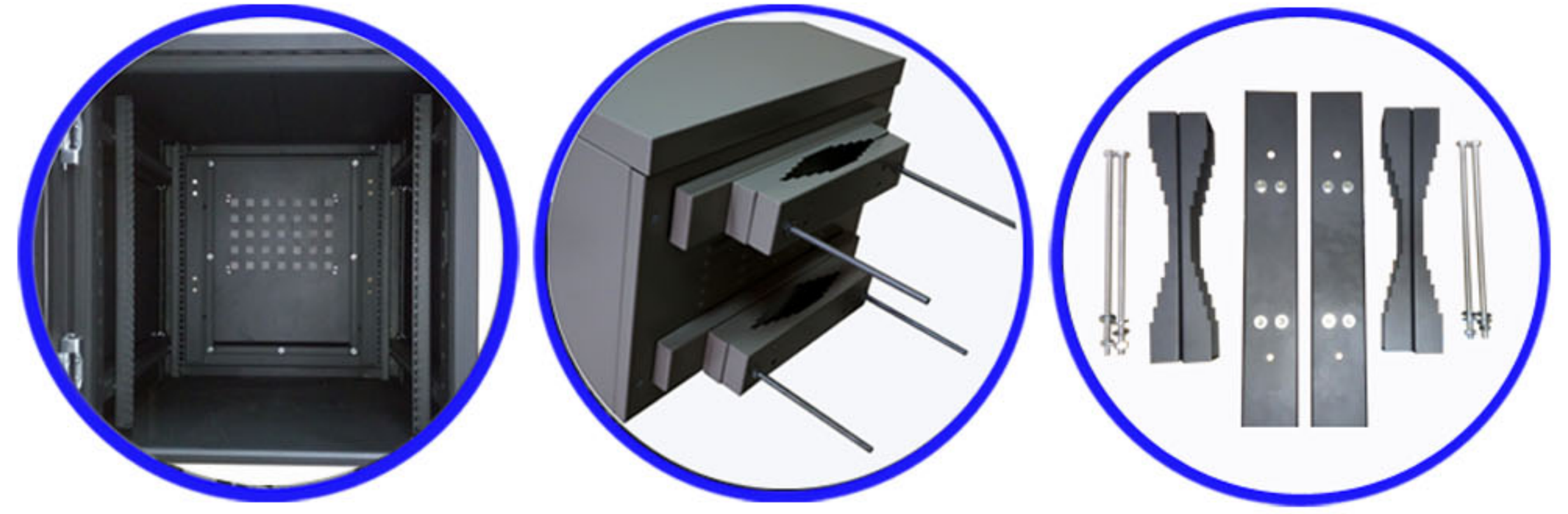

### Features:

1. 19" Outdoor Wallmounted rack type
2. Outdoor cabinet category IP31, IP55, IP56, IP65 etc
3. High quality powder coated, construction and design
4. Flexible installation : makes it possible mount to the wall and pole suits both indoor and outdoor
5. Fixed mounting rails for support of patch panels, termination blocks and other equipments
6. Various optional accessories according to requirements ( cable management, pdu, fans, utp panel, fo panel, etc )

7. Material options : SPCC Steel, Aluminium and Stainless Steel
8. Available customized on requirements

Specification Wallmounted Rack Outdoor				
Part Number	Size	Width (mm)	Height (mm)	Depth (mm)
ABBA-W08U6060-IP55-RAL7035	8U	600	465	600
ABBA-W09U6060-IP55-RAL7035	9U	600	510	600
ABBA-W12U6060-IP55-RAL7035	12U	600	650	600
ABBA-W15U6060-IP55-RAL7035	15U	600	780	600

## Wallmount Outdoor with Cooling



More Details :



### Features:

1. 19" wallmount rack built in with the cooling for self containment for security purposes.
2. Available with IP Rate category IP55, IP65, IP66, etc.
3. Air conditioner door mounted, all in one unit.
4. Cooling capacity 300W.
5. Flexible installation, pole or wall mounted
6. Optional with base for standing installation
7. High quality powder coated, construction and design
8. Material options : SPCC Steel, Aluminium and Stainless Steel
9. Color options: RAL7035 & RAL9005
10. Available customized on requirements

### Specification Wallmount Outdoor with Cooling

Part Number	Size	Width (mm)	Height (mm)	Depth (mm)
ABBA-W12U6060-AC-IP55	12U	600	650	600
ABBA-W15U6060-AC-IP55	15U	600	780	600

## Junction Box (JB)

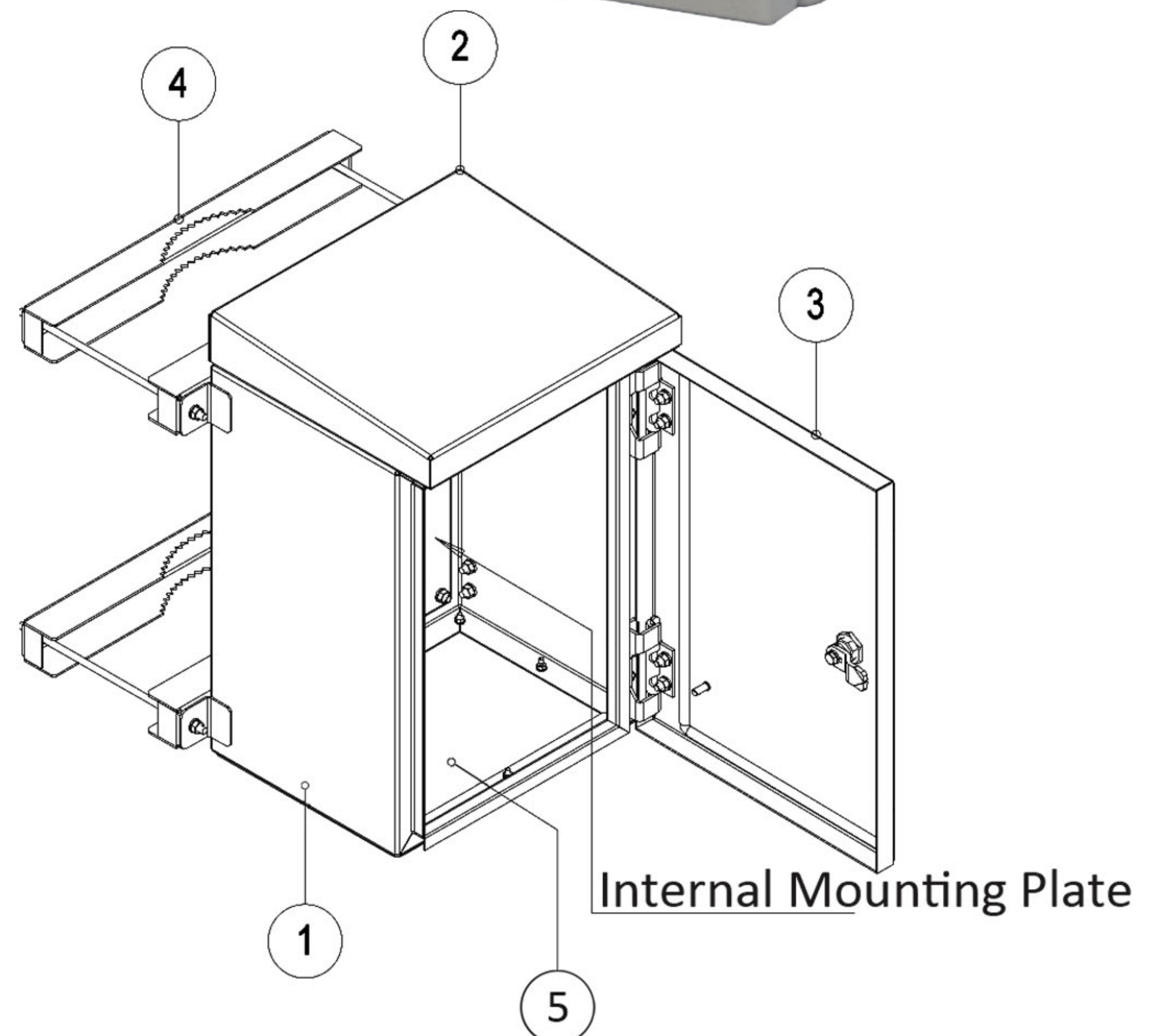

### Features:

1. Junction Box designed for use in indoor or outdoor
2. Available with IP Rate category IP55, IP65, IP66, etc.
3. Flexible installation, pole or wall mounted
4. Optional with base for standing installation
5. High quality powder coated, construction and design
6. Material : SPCC Steel, Aluminium or Stainless Steel
7. Available customized on requirements

### Part Name :

1. Junction Box / Cabinet
2. Top / Canopy with Gasket
3. Front Door with Gasket
4. Wall / Pole Bracket
5. Gland Plate with Gasket



More Details :

Specification Junction Box				
Part Number	IP Rate	Height (mm)	Width (mm)	Depth (mm)
ABBA-JB-IP66-303025	IP66	300	300	250
ABBA-JB-IP66-403025	IP66	400	300	250
ABBA-JB-IP66-604025	IP66	600	400	250
ABBA-JB-IP66-705025	IP66	700	500	250

## Junction Box (JB) With Cooling

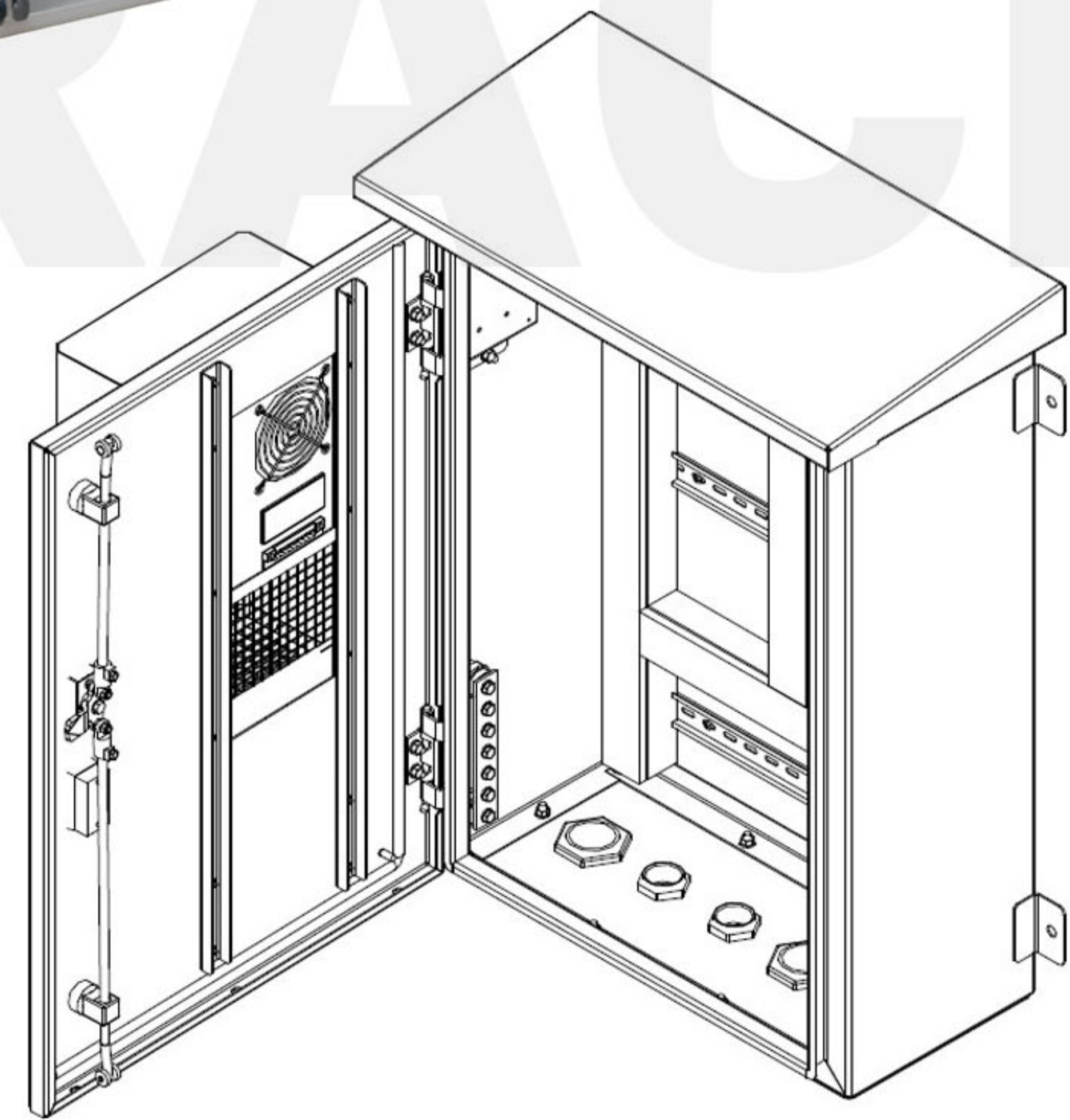

### Features:

1. Junction Box designed for use in indoor or outdoor
2. Available with IP Rate category IP55, IP65, IP66, etc.
3. Air conditioner doormounted, all in one unit.
4. Cooling capacity 300W.
5. Flexible installation, pole or wall mounted
6. Optional with base for standing installation
7. High quality powder coated, construction and design
8. Material : SPCC Steel , Aluminium or Stainless Steel
9. Color : RAL 7035
10. Available customized on requirements



More Details :

Specification Junction Box with Cooling				
Part Number	IP Rate	Height (mm)	Width (mm)	Depth (mm)
ABBA-JBIP66-504020-AC300	IP66	500	400	200
ABBA-JBIP66-705025-AC300	IP66	700	500	250

## Telco & Battery Rack



**Colour**



Black Grey



More Details :

### Telco & Battery Rack Features:

1. Ideal for Telco and Battery System
2. 19" standard installation
3. High quality construction and design
4. High quality powder coated
5. Ideal for telecommunications applications
6. Available customized on requirements

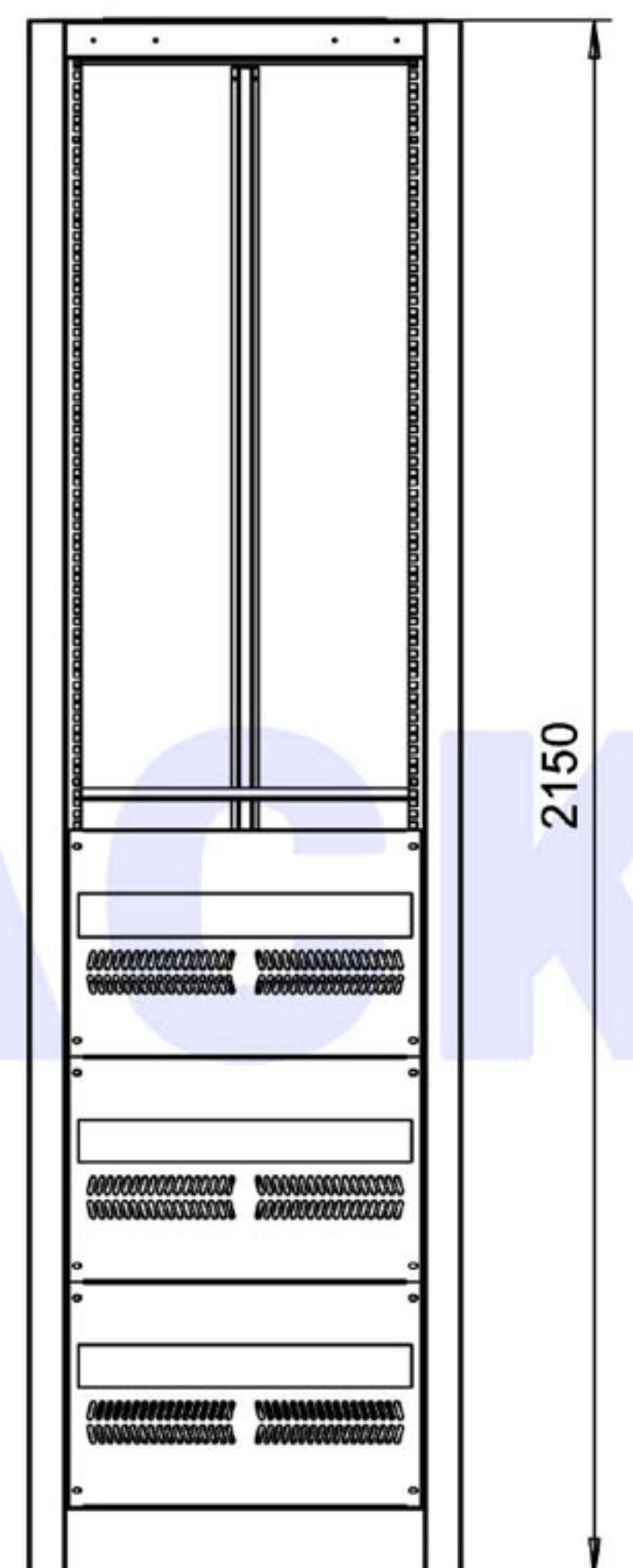
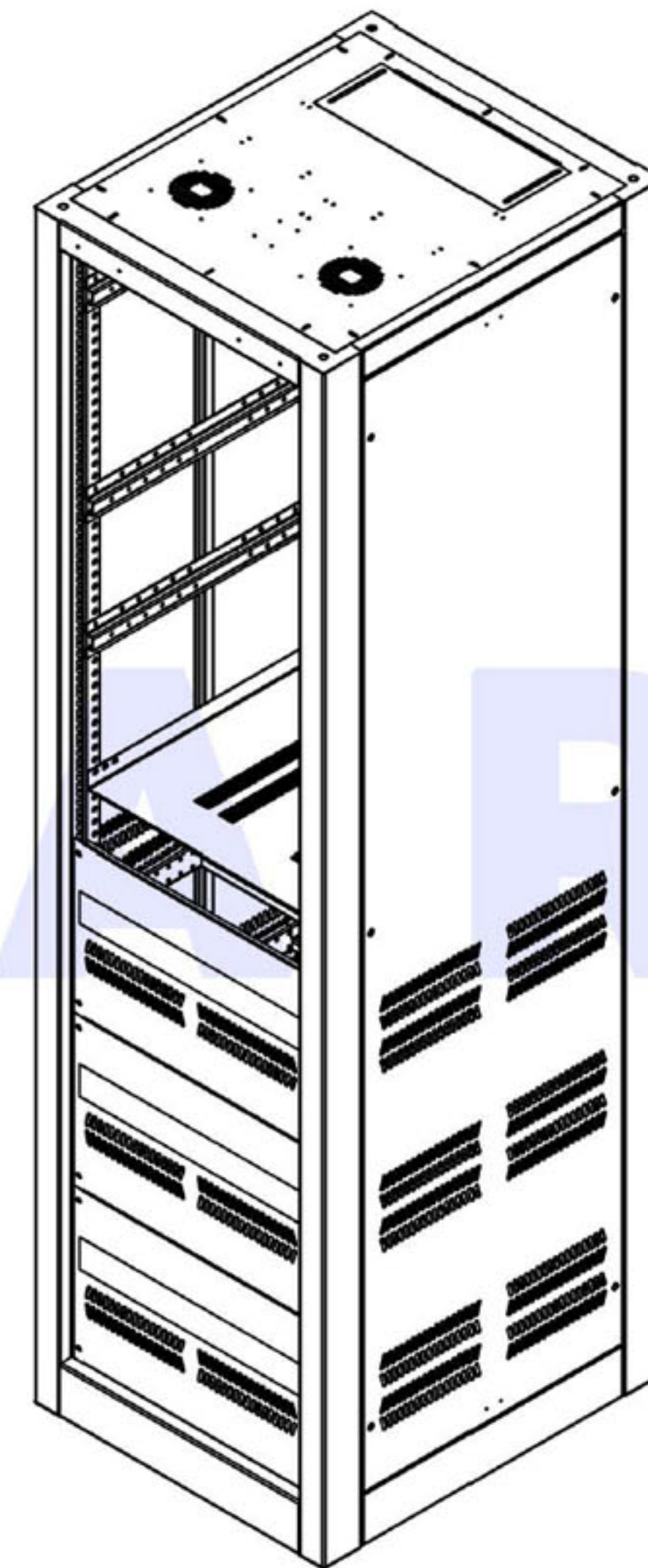
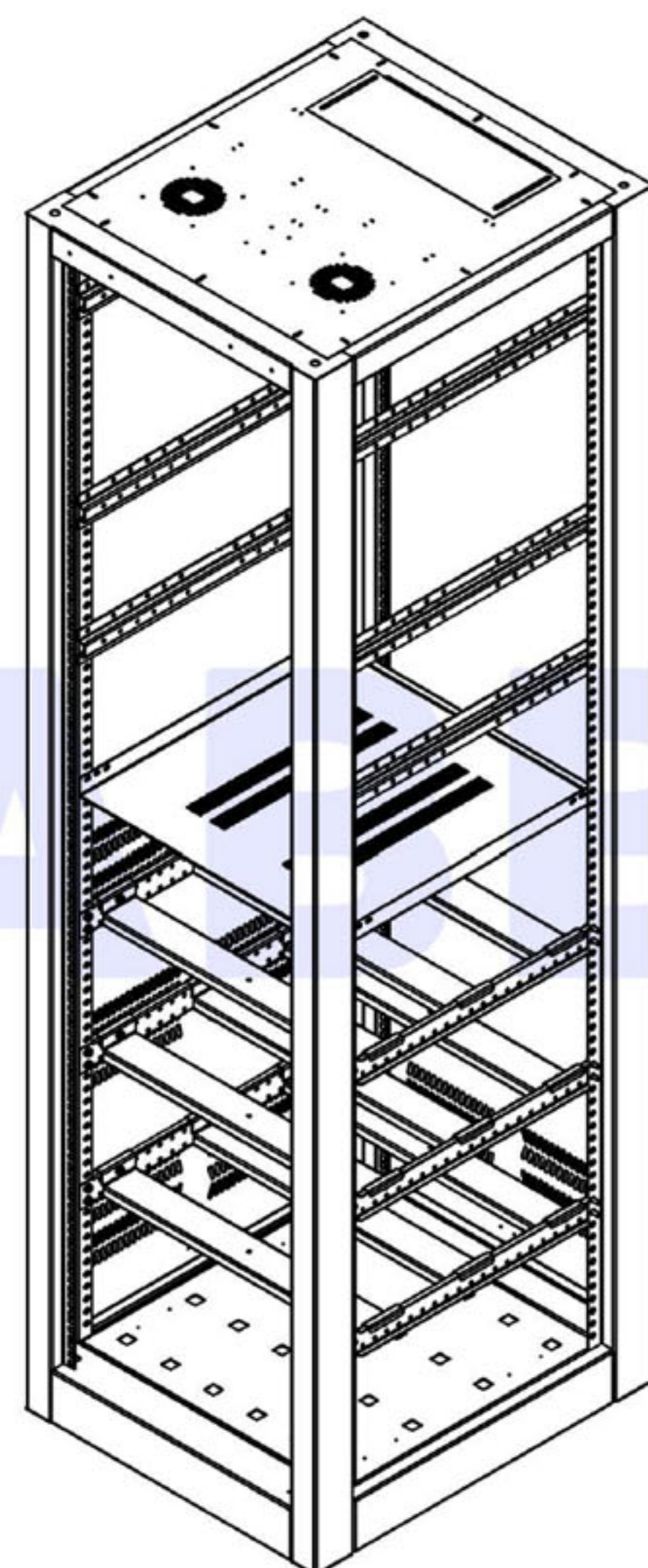

Specification Telco & Battery Rack - Customized Rack				
Part Number	Size	Width (mm)	Height (mm)	Depth (mm)
ABBA-TBR-42-700-G/B	42U	600	2025	700
ABBA-TBR-45-700-G/B	45U	600	2150	700

## Backup Tape Rack (LTO Rack)



More Details :

### Backup Tape Rack Features :

1. Ideal for store and manage the backup tapes (LTO cartridge)
2. Closed rack design for security purpose
3. Each drawer has locking system
4. Dimension : (H.1800 X W.600 X D.600) mm
5. Available in 11 drawer
6. Available store up to 68 tapes / drawer or total 748 tapes /rack
7. Available free standing
8. Removable single side panel with lock
9. Easy to use/access rollout drawers
10. High quality powder coated
11. No assembly required
12. Available customized on requirements

Part Number : ABBA-BTR-11-G/B

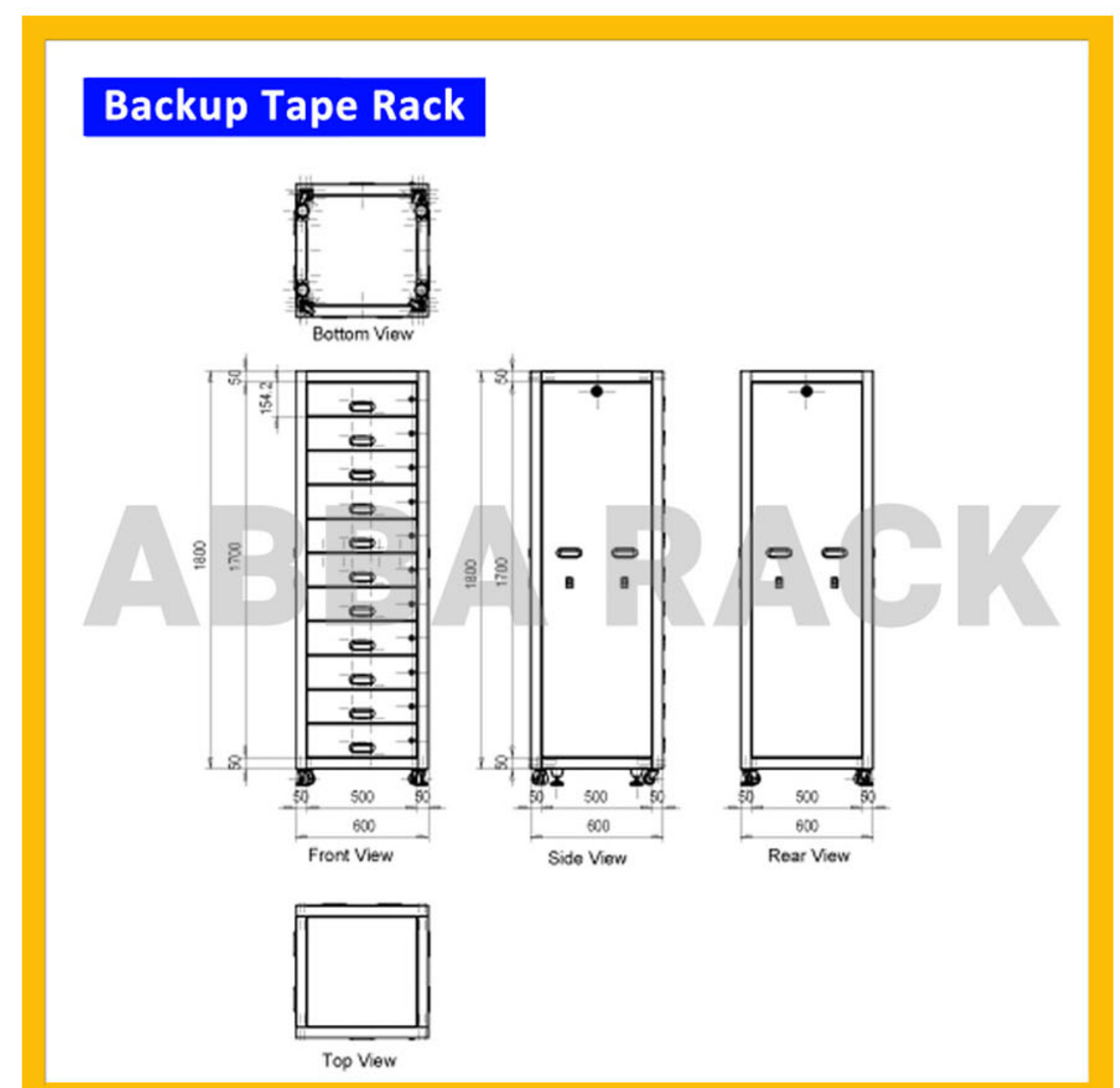

## Data Center Solutions (CAC)

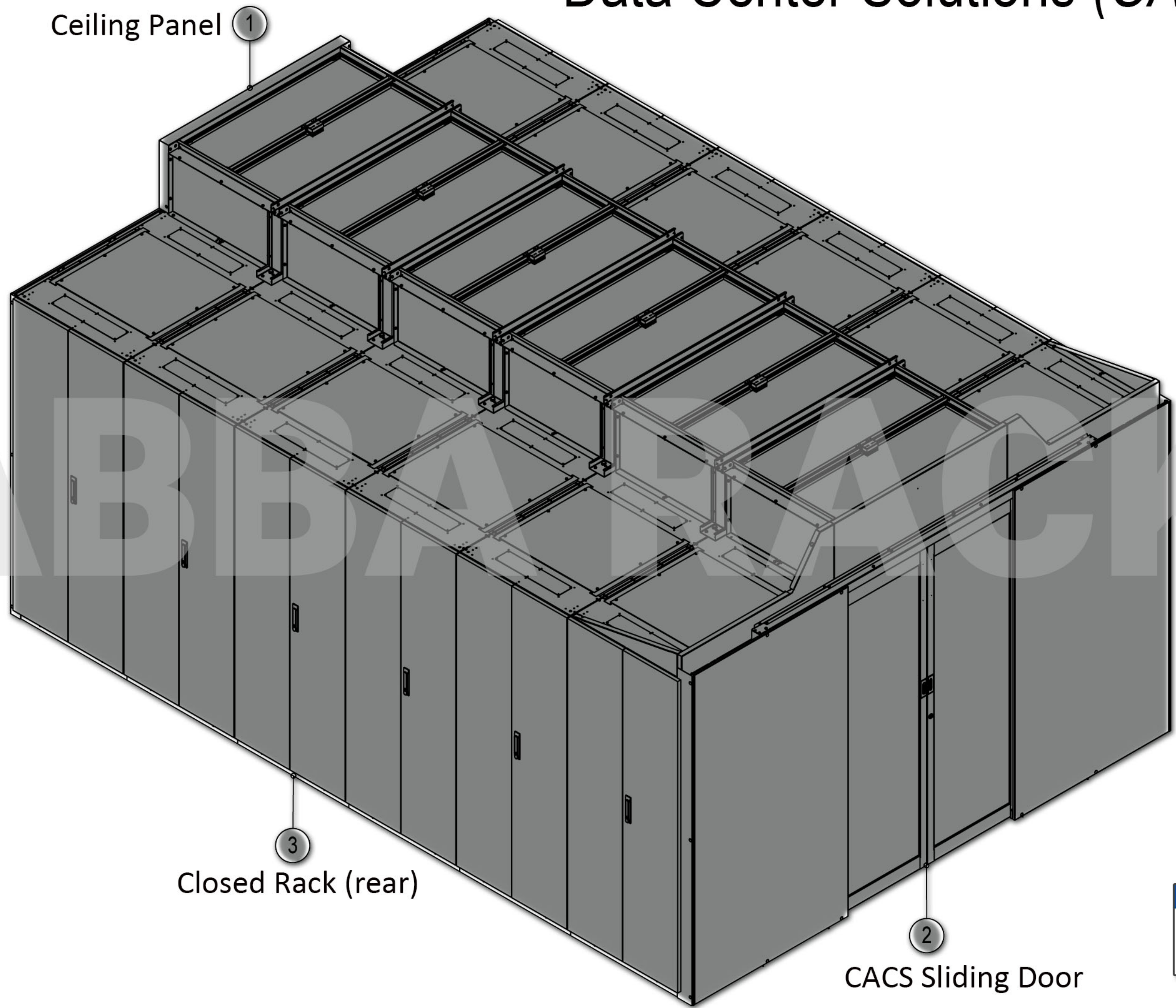

More Details :



### Features :

1. Isolates cold aisles and hot aisles from each other and prevents cold and hot air from mixing.
2. Optimize cooling system efficiency.
3. Increase energy savings and optimize power availability.
4. Reduce energy cost.
5. Easy to retrofit an old data center with the containment system.
6. Modular system, flexible and easy to assemble.
7. Customizable design.
8. Helpful to achieve to be a green data center for the environment.
9. Ceiling panel : automatically open when received signal/trigger from fire system.
10. Available model with Hot Aisle Containment System (HAC).

## Data Center Solutions (HAC)

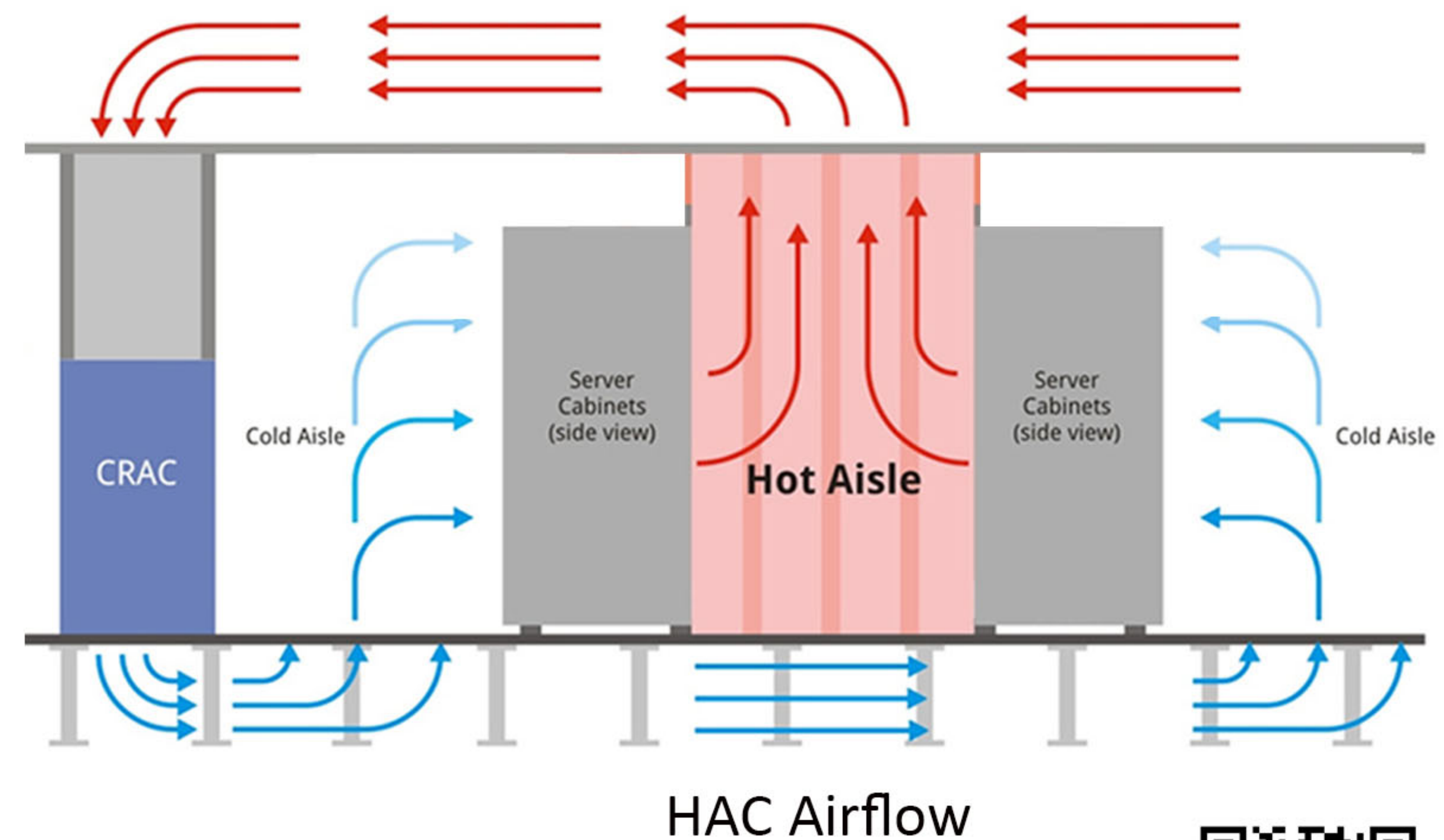
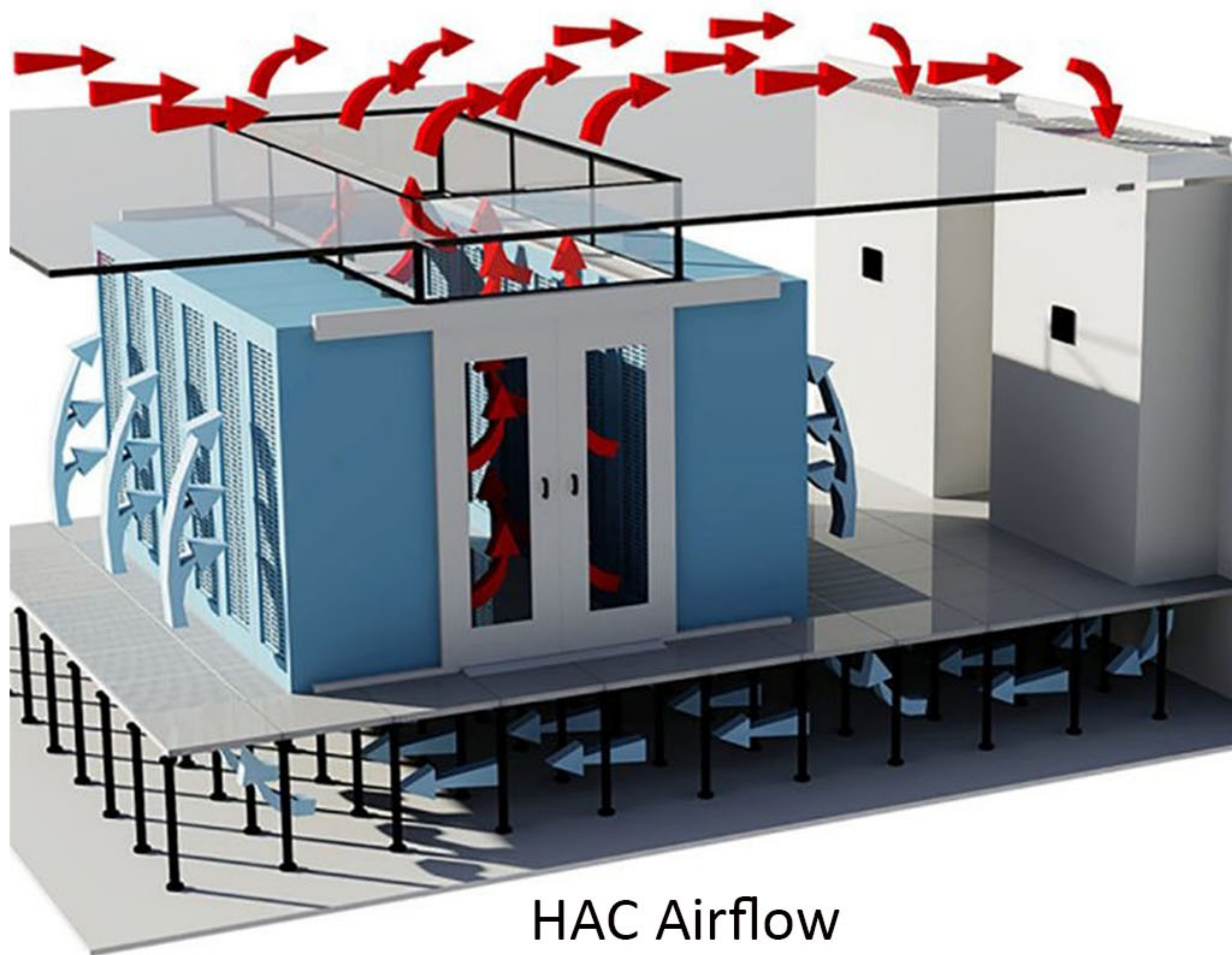
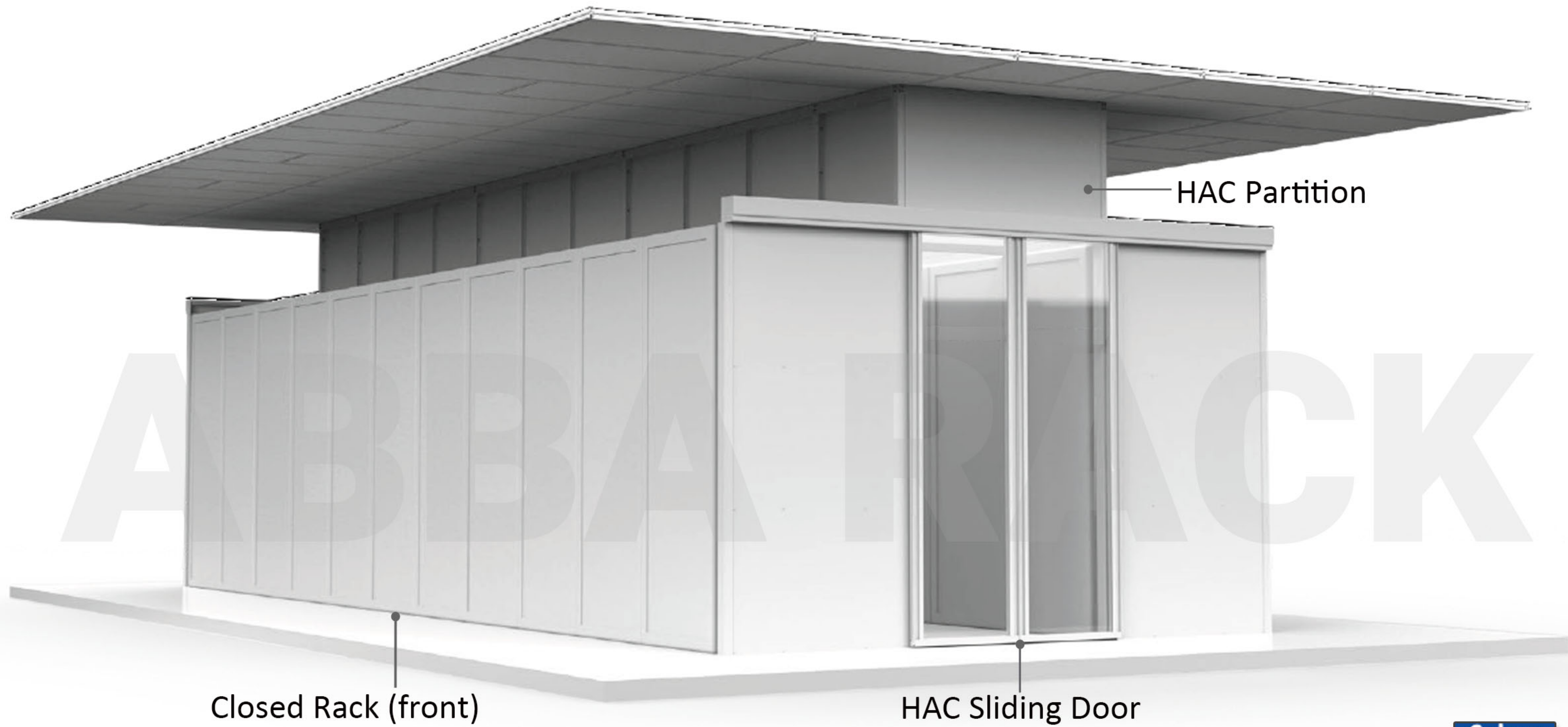

[More Details :](#)

### Features :

1. Isolates hot aisles and cold aisles from each other and prevents hot and cold air from mixing.
2. Optimize cooling system efficiency.
3. Increase energy savings and optimize power availability.
4. Reduce energy cost.
5. Keeps the whole room cold, improves the overall comfort level within the data center.
6. Modular system, flexible and easy to assemble.
7. Customizable design.
8. Helpful to achieve to be a green data center for the environment.
9. HAC partition options: SPCC mild steel, Aluminum, Polycarbonate.
10. Available model with Cold Aisle Containment System (CAC).

## Data Center Solutions



ABBA-RACK cages system provide a method of segregating customer racks and equipment into defined zones, providing a high level security for equipment which is contains multiple user. With the increasing need to provide a secure method of housing equipment within a co-location data center, ABBA-RACK Cages system can provide and install with the customized design.

### Features :

1. Provide security enhanced for data center environments
2. Height 2400mm or customized height
3. Varying Panels designs with a width of 1200mm and height of 1200mm or can be customized
4. Optional key and electronic locking system
5. Modular design and easily expandable
6. High quality powder coated, construction and design
7. Available customized on requirements



More Details :

Roof FAN



Single FAN



PDU



Flat Shelf



Wire Management



Brush Panel



Cage Nut

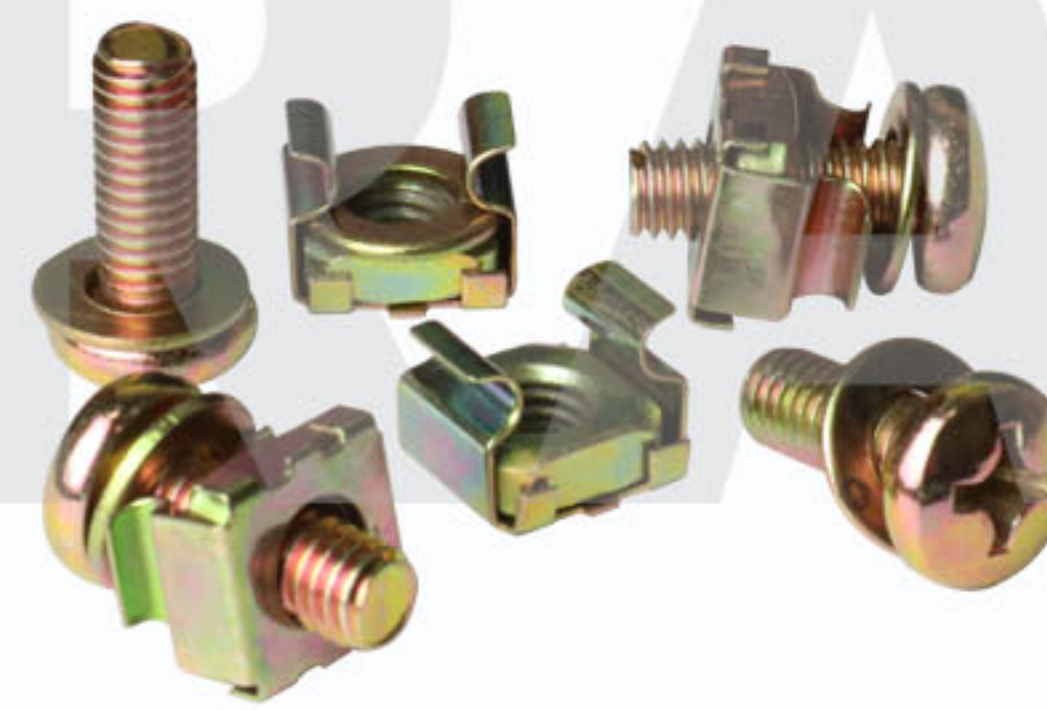

Grounding Cable



Grounding Busbar



Cable Tray



Cable Duct

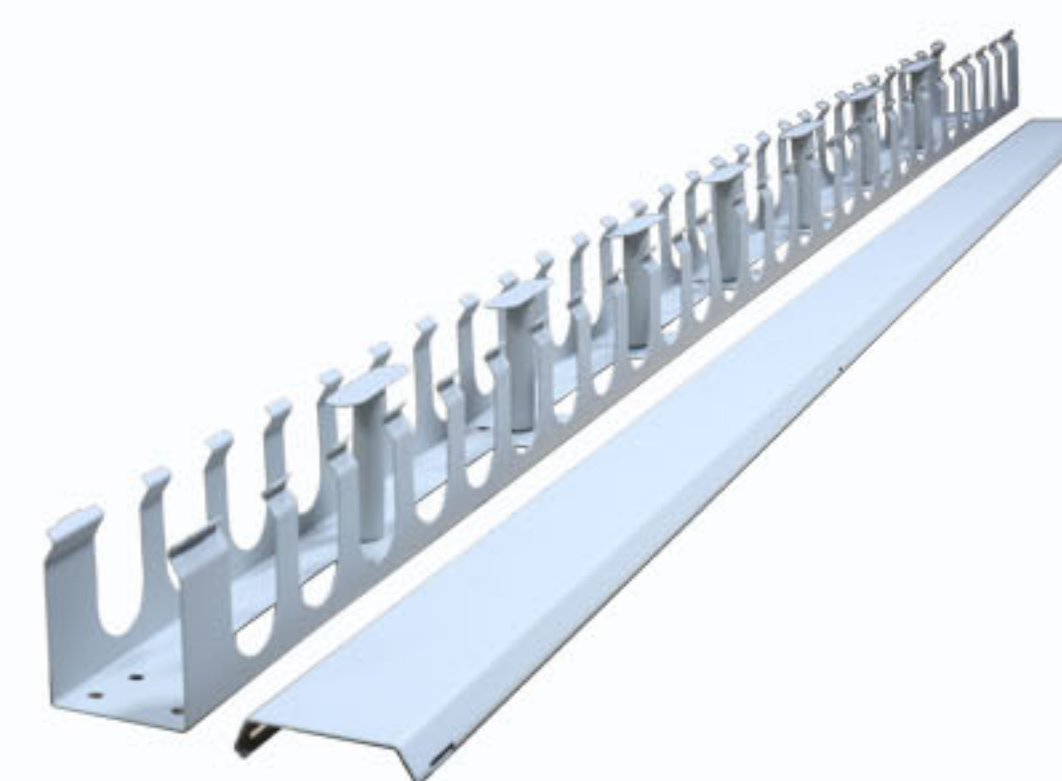

LED Light Bar



Adjustable Shelf



Telescopic Drawer  
with Pivot



Telescopic Drawer



Flat Shelf for Open Rack



Blank Panel



Dynabolt



Castor



Digital Temperature



More Details :

Digital Temperature Unit

with FAN



Basic PDU 32A



Metered PDU



Smart PDU



UTP Patchcord



FO Patchcord



UTP Patch Panel



OTB / FO Panel



Cantilever



Dual Feed PDU

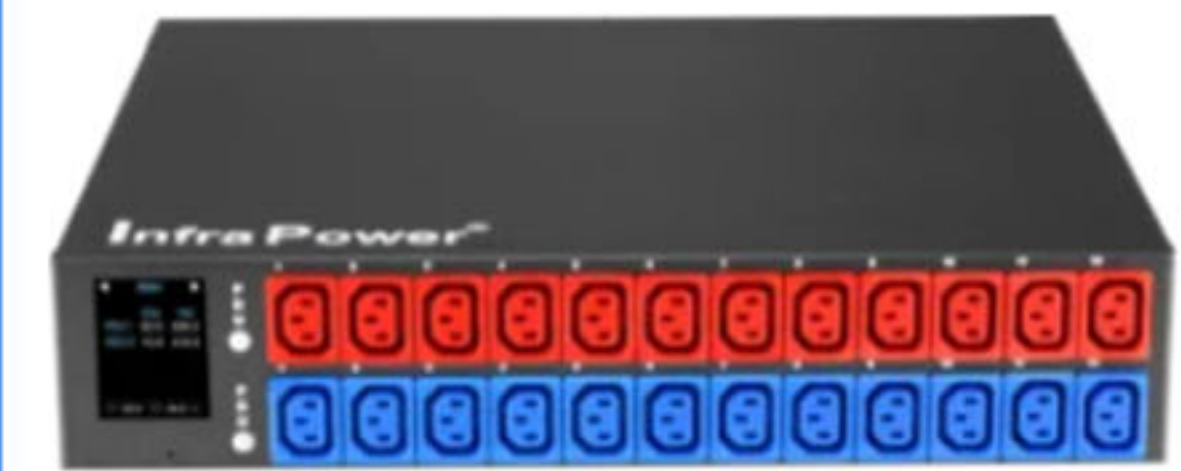

ATS



In Line Meter

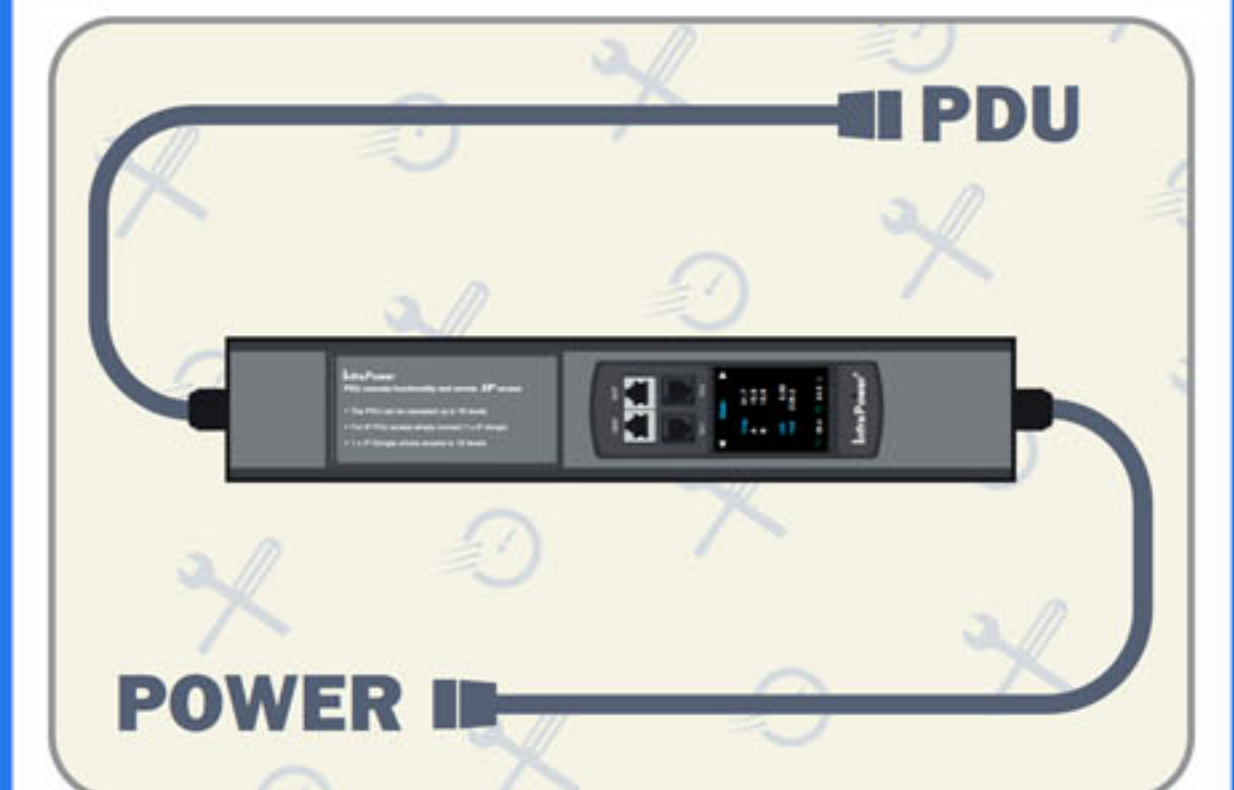

Rack Sensor



1U Rackmount Fan Tray

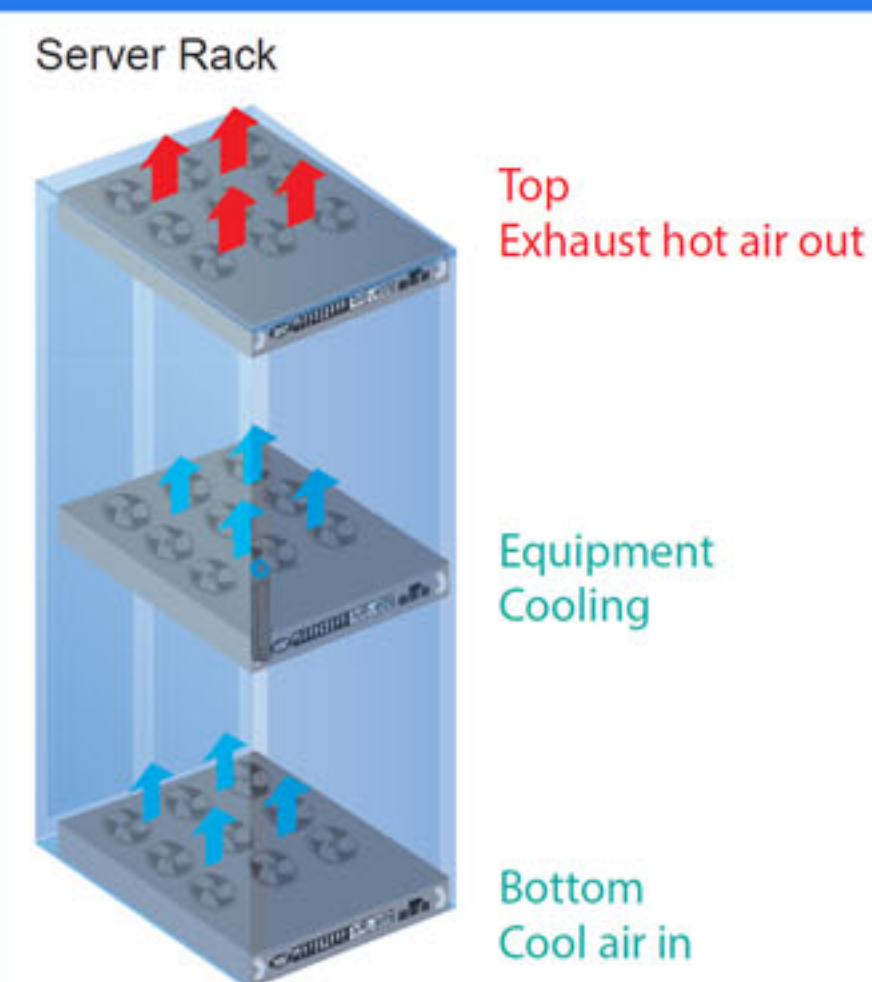

Door Mount Fan Panel

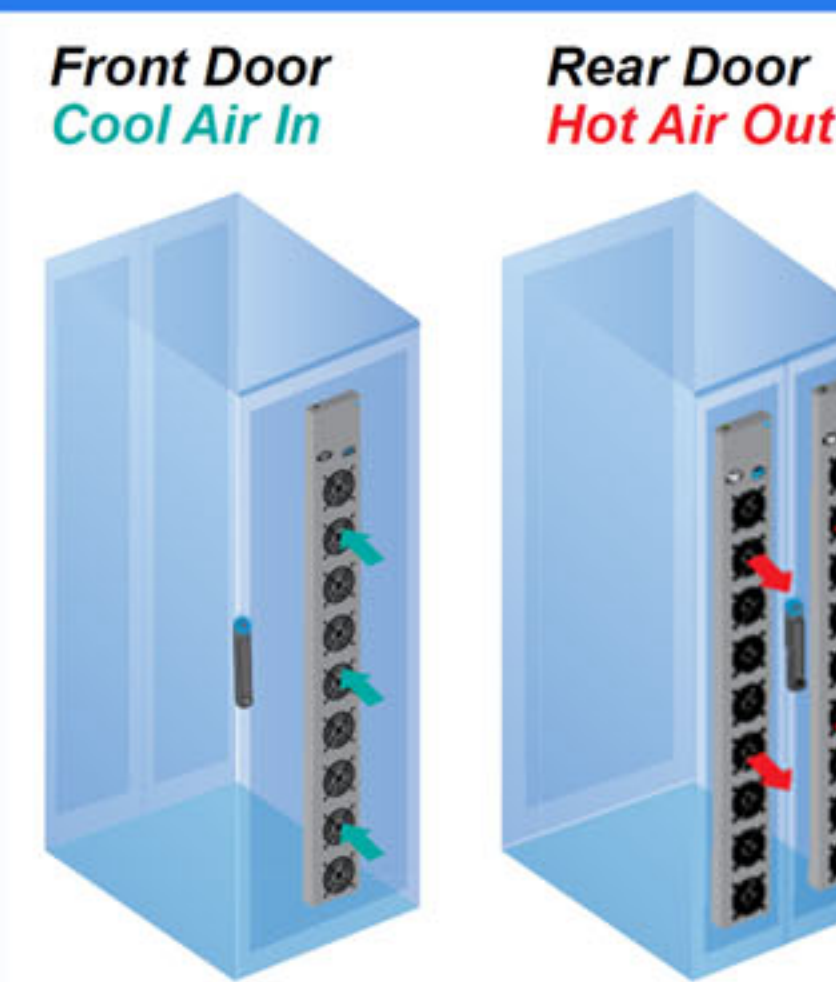

Raised Floor Mount Fan



MiniBoot



Rack Access Control



LCD Console Drawer



KVM Switch



More Details :



### Features :

1. High Quality construction and design.
2. 19" Standard installation.
3. High secure with handle front & rear door.
4. Glass front door and perforated rear door with hexagon perforated.
5. Removable dual side panel with locking system.
6. Cable entry at the top cover and bottom panel with brush panel.
7. Removable side panels for ease of installation and service access.
8. Grounding cable supported.
9. Modular fan panel include the fans which ease installation for maximize airflow system..
10. Include : adjustable leveling feet and castor.
11. Include : cable ring & fixed shelf.
12. Include : fan, cage nut & PDU.
13. Delivery in assembly or disassembly.

#### Specification Closed Rack - Glass Door & Perforated Back Door

Part Number	Size	Width (mm)	Height (mm)	Depth (mm)	Weight (kg)
AR-C20-600-GB	20U	600	1080	600	65
AR-C20-900-GB	20U	600	1080	900	79
AR-C20-1150-GB	20U	600	1080	1150	106
AR-C30-900-GB	30U	600	1520	900	95
AR-C30-1150-GB	30U	600	1520	1150	123
AR-C42-600-GB	42U	600	2050	600	83
AR-C42-900-GB	42U	600	2050	900	111
AR-C42-1150-GB	42U	600	2050	1150	139

### Key benefits :

● Color : RAL9004 Black

kg Max Static Load 800kg



Handle Front & Rear w/ Hexagon Vented



Dual side panel w/ locking system



Modular Fan & Brush panel

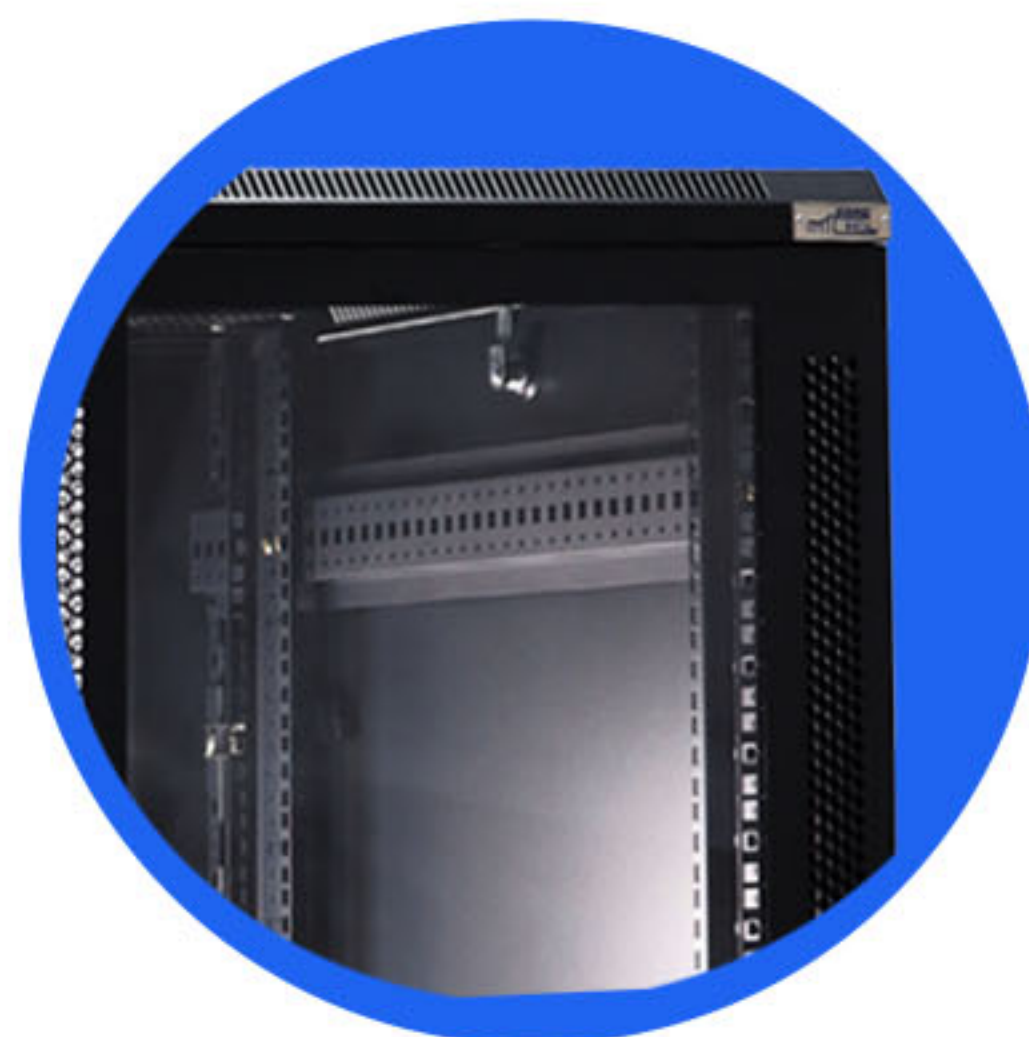

Glass front door Top & bottom vented



Grounding cable

#### Features :

1. High Quality construction and design.
2. 19" Standard installation.
3. High secure with handle front door and side panel locking system.
4. Perforated front door and Perforated Back Door with hexagon vented.
5. Cable entry at the top cover and bottom panel with brush panel.
6. Removable side panels for ease of installation and service access.
7. Grounding cable supported.
8. Modular fan panel include the fans which ease installation for maximize airflow system.
9. Include : adjustable leveling feet and castor.
10. Include : cable ring & fixed shelf.
11. Include : fan, cage nut & PDU.
12. Delivery in assembly or disassembly.
13. Available with Perforated Door & Split Door



#### Specification Closed Rack - Perforated Door Front & Rear

Part Number	Size	Width (mm)	Height (mm)	Depth (mm)	Weight (kg)
AR-C20-600-PB	20U	600	1080	600	65
AR-C20-900-PB	20U	600	1080	900	79
AR-C20-1150-PB	20U	600	1080	1150	106
AR-C30-900-PB	30U	600	1520	900	95
AR-C30-1150-PB	30U	600	1520	1150	123
AR-C42-900-PB	42U	600	2050	900	111
AR-C42-1150-PB	42U	600	2050	1150	139

#### Key benefits :

 Color : RAL9004 Black

 Max Static Load 800kg



Handle front door w/ Hexagon Vented



Perforated Door Top & Bottom Vented



Removable side panel w/ locking system



Fans system & Brush panel



Cable Ring



Grounding cable

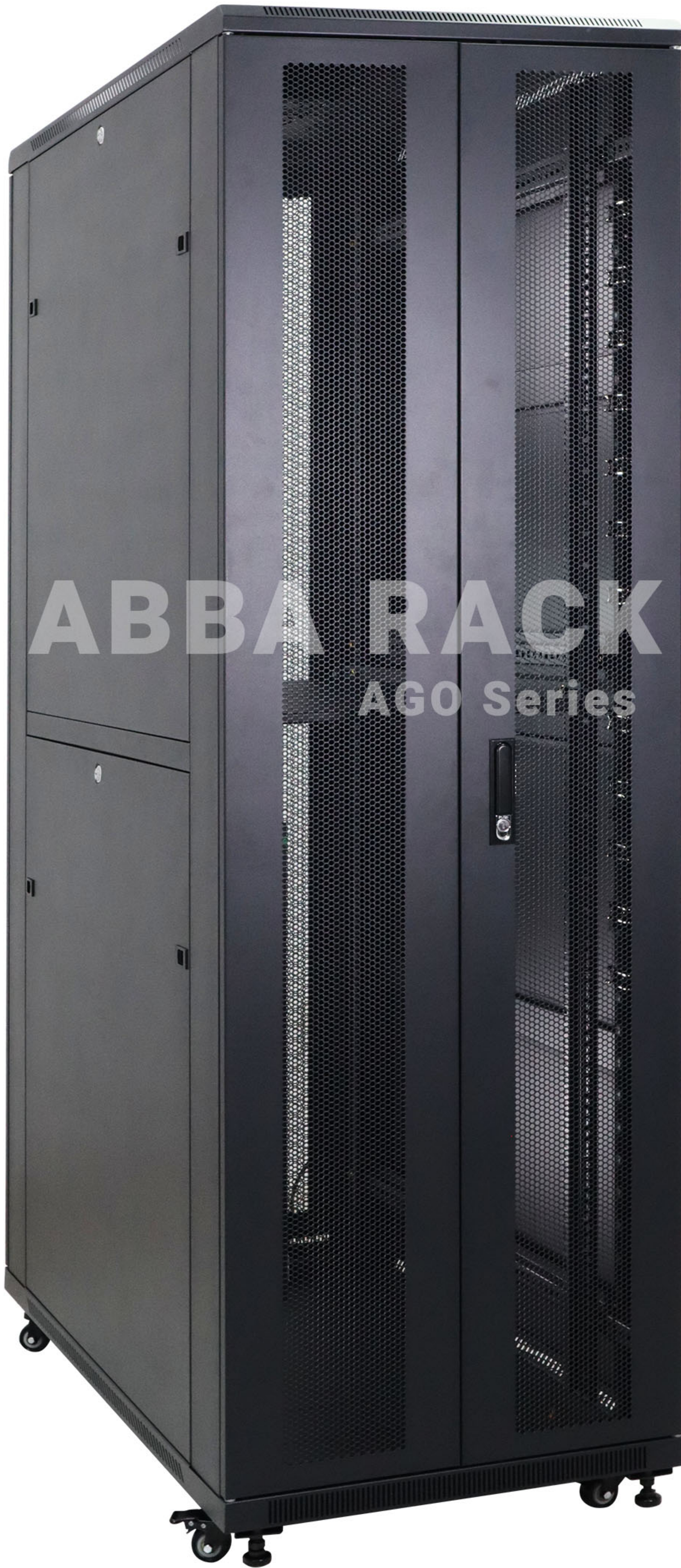

#### Features :

1. High Quality construction and design.
2. 19" Standard installation.
3. High secure with handle front door and side panel locking system.
4. Perforated front door and Split Door door with hexagon vented.
5. Cable entry at the top cover and bottom panel with brush panel.
6. Removable side panels for ease of installation and service access.
7. Grounding cable supported.
8. Modular fan panel include the fans which ease installation for maximize airflow system.
9. Include : adjustable leveling feet and castor.
10. Include : cable ring & fixed shelf.
11. Include : fan, cage nut & PDU.
12. Delivery in assembly or disassembly.

#### Specification Closed Rack - Perforated Door & Split Door

Part Number	Size	Width (mm)	Height (mm)	Depth (mm)	Weight (kg)
AR-C20-900-TB	20U	600	1080	900	79
AR-C20-1150-TB	20U	600	1080	1150	106
AR-C30-900-TB	30U	600	1520	900	95
AR-C30-1150-PB	30U	600	1520	1150	123
AR-C42-900-PB	42U	600	2050	900	111
AR-C42-1150-PB	42U	600	2050	1150	139

#### Key benefits :

 Color : RAL9004 Black

 Max Static Load 800kg



Handle front door w/ Hexagon Vented



Split Back Door



Removable side panel w/ locking system



Fans system & Brush panel



Cable Ring



Grounding cable



#### Features :

1. High Quality construction and design.
2. 24" Standard installation.
3. High secure with handle front door and side panel locking system.
4. Perforated front door and Split Door door with hexagon vented.
5. Cable entry at the top cover and bottom panel with brush panel.
6. Removable side panels for ease of installation and service access.
7. Grounding cable supported.
8. Modular fan panel include the fans which ease installation for maximize airflow system.
9. Include : adjustable leveling feet and castor.
10. Include : vertical cable duct.
11. Include : cable ring & fixed shelf.
12. Include : fan, cage nut & PDU.
13. Delivery in assembly or disassembly.
14. Available with Perforated Split Rear Door

#### Specification Closed Rack - Perforated Door & Split Door

Part Number	Size	Width (mm)	Height (mm)	Depth (mm)	Weight (kg)
AR-C42-21150-TB	42U	800	2050	1150	150

#### Key benefits :

 Color : RAL9004 Black

 Max Static Load 500kg



Handle front door w/ Hexagon Vented



Split Back Door



Removable side panel w/ locking system



Fans system & Brush panel



Vertical Cable Duct



Grounding cable



● Color : RAL9004 Black

#### Key benefits :

Wallmounted rack is the good solution for the network distribution room with limited space and absolutely has cost effective. Our wallmount rack come in sizes, heights and depths with compact design. The wallmounted rack has removable side panels for ease of installation and service access. This cabinet is perfect for almost any wiring room.

#### Features :

1. High Quality construction and design.
2. 19" Standard installation.
3. High secure with handle front door and side panel locking system.
4. Acrylic front door with hexagon vented.
5. Cable entry at the top cover and bottom panel.
6. Single door and removable side panels for ease of installation and service access.
7. Grounding cable supported.
8. Fans for maximize airflow system.
9. Include : fan, cage nut, dynabolt & PDU.
10. Delivery in assembly or disassembly.

#### Specification Wallmount Rack - Single Door

Part Number	Size	Width (mm)	Height (mm)	Depth (mm)	Weight (kg)
AR-W04-500-SB	4U	600	278	500	13
AR-W06-500-SB	6U	600	367	500	14
AR-W08-500-SB	8U	600	456	500	16
AR-W12-500-SB	12U	600	634	500	19
AR-W15-500-SB	15U	600	767	500	20



Handle front door w/ Hexagon Vented



Removable side panel w/ locking system



Fans system



Acrylic front door Top & bottom vented

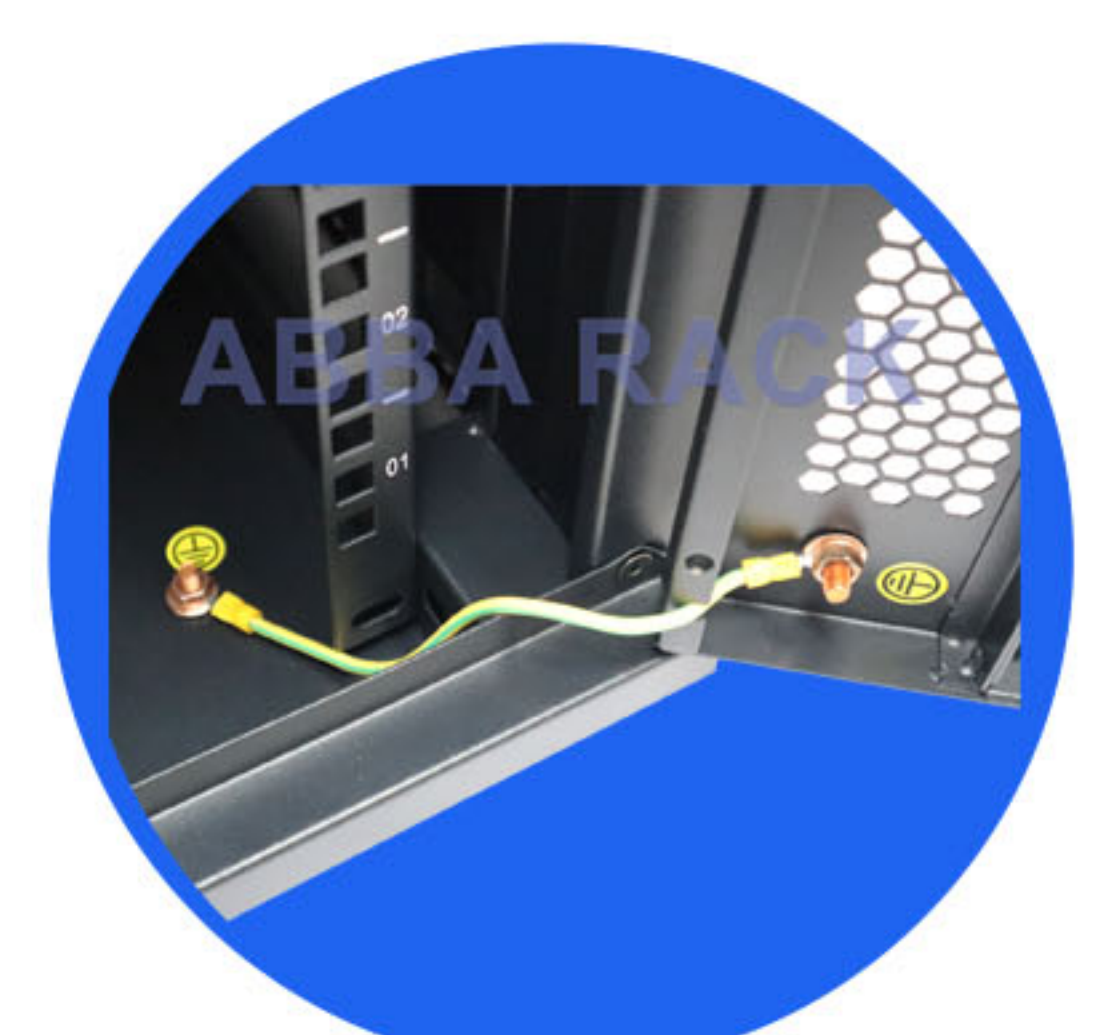

Grounding cable



Wallmounted rack is the good solution for the network distribution room with limited space and absolutely has cost effective.

Our wallmount rack come in sizes, heights and depths with compact design.

The wallmounted rack has removable side panels for ease of installation and service access.

This cabinet is perfect for almost any wiring room.

### Features :

1. High Quality construction and design.
2. 19" Standard installation.
3. High secure with handle front door and side panel locking system.
4. Acrylic front door with hexagon vented.
5. Cable entry at the top cover and bottom panel.
6. Double door and removable side panels for ease of installation and service access.
7. Grounding cable supported.
8. Fans for maximize airflow system.
9. Include : fan, cage nut, dynabolt & PDU.
10. Delivery in assembly or disassembly.

### Specification Wallmount Rack - Double Door

Part Number	Size	Width (mm)	Height (mm)	Depth (mm)	Weight (kg)
AR-W08-600-DB	8U	600	456	600	21
AR-W12-600-DB	12U	600	634	600	24
AR-W15-600-DB	15U	600	767	600	26
AR-W15-750-DB	15U	600	767	750	33

### Key benefits :

● Color : RAL9004 Black



Handle front door w/ Hexagon Vented



Removable side panel w/ locking system



Double door Ease installation



Acrylic front door Top & bottom vented

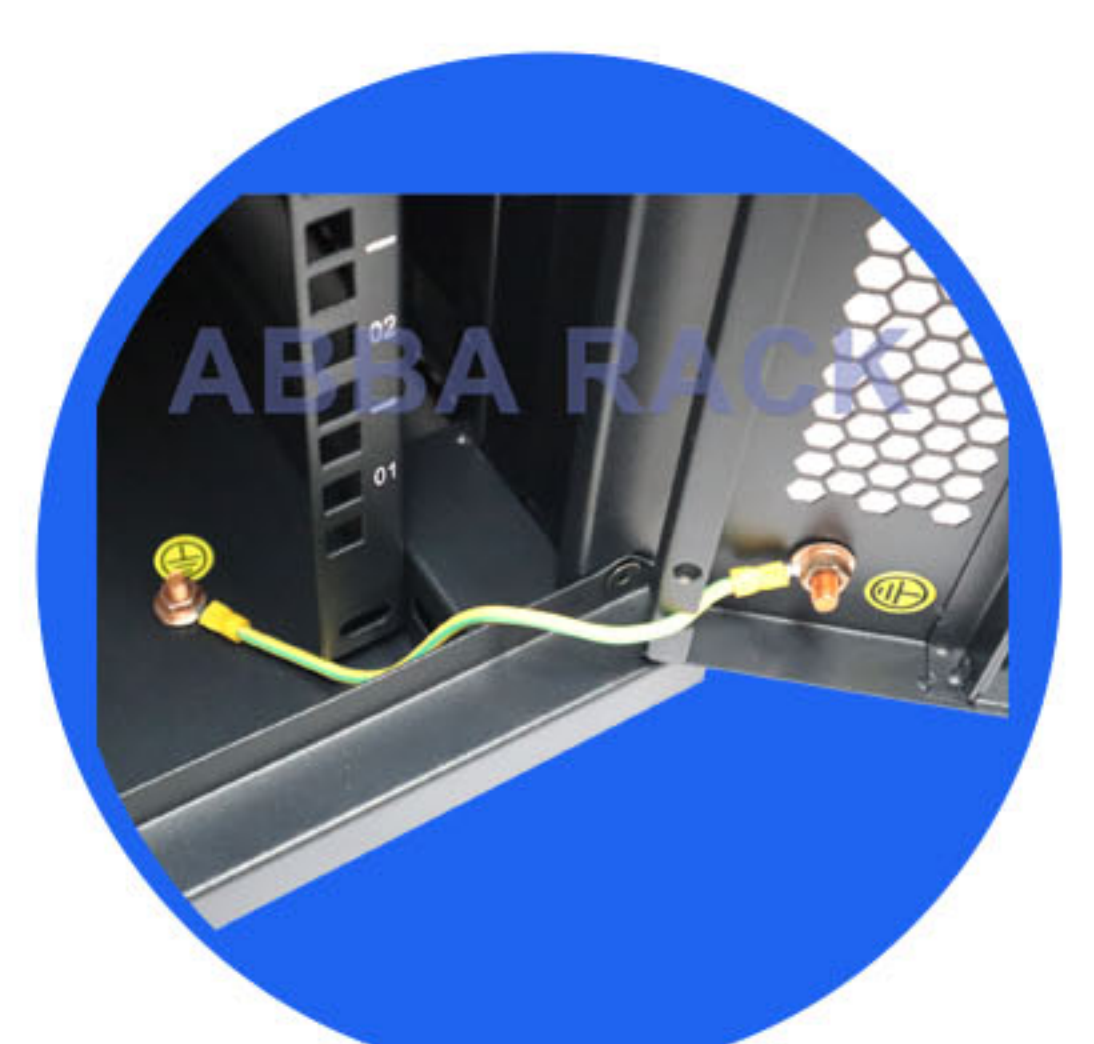

Grounding cable



**Features :**

1. 19" Outdoor Wallmounted rack type
2. Outdoor cabinet category IP55
3. High quality powder coated, construction and design
4. Flexible installation : makes it possible mount to the wall and pole suits both indoor and outdoor
5. Fixed mounting rails for support of patch panels, termination blocks and other equipments
6. Cable entry for at the bottom panel
7. Grounding cable supported
8. Include : Fan, Cagenut, Dynabolt, & PDU
9. Various optional accessories according to requirements ( cable management, pdu, fans, utp panel, fo panel, etc )
10. Material options : SPCC Steel

**Specification Wallmount Rack - Double Door**

Part Number	Size	Width (mm)	Height (mm)	Depth (mm)	Weight (kg)
AR-W08U6060-IP55	8U	600	556	600	21
AR-W12U6060-IP55	12U	600	735	600	25
AR-W15U6060-IP55	15U	600	870	600	30

**Key benefits :**

 **Color : RAL7035**



Font door w/ Handle



Fans System



Document Holder & 3 Point Lock



Pole Mounted Bracket



Grounding Busbar

**ABBA RACK CONTACT US**



# **PT. UNI NETWORK COMMUNICATIONS**

*Jl. Batu Jajar No.11A, Sawah Besar, Jakarta Pusat, Indonesia - 10120*

*Telp. : 021 351 2977 (Hunting)*

*WhatsApp : 0812 6000 1880*

*Email : [sales@abba-rack.com](mailto:sales@abba-rack.com)*

**ABBA  
RACK**  
[www.abba-rack.com](http://www.abba-rack.com)

*We will become a business partner that grows together*